



# McKinney & Co

BRITISH CURTAIN POLES & FINIALS

Collection Brochure >

# Index

<b>Introduction</b>	<b>3</b>	Plain Metal	62
<b>The London Collection</b>	<b>4</b>	Twisted Metal	63
<b>The Steel Collection</b>	<b>8</b>	Reeded Metal	64
<b>The Café Rods Collection</b>	<b>15</b>	Fine Reeded Metal	65
<b>The McKinney Collection</b>	<b>19</b>	Perspex	66
<b>Finials</b>	<b>25</b>	Square Poles	67
Classical	26	Rectangular Poles	68
Heritage	30	Double Pole System	69
Modern	33	Half Poles	70
Eclectic	35	French Returns	71
Naturalistic	37	<b>Pelmets &amp; Coronas</b>	<b>72</b>
Spherical	41	<b>Tie Backs</b>	<b>76</b>
Square	45	Glass & Perspex	78
Glass & Perspex	47	Metal	81
Metal	53	Wood & Resin	85
End Caps	55	<b>Accessories</b>	<b>88</b>
<b>Curtain Poles</b>	<b>56</b>	<b>Brackets &amp; Facings</b>	<b>93</b>
Plain Wood	57	<b>Finishes</b>	<b>101</b>
Reeded Wood	58	<b>Guideline</b>	<b>108</b>
Fine Reeded Wood	59	<b>Terms &amp; Conditions</b>	<b>113</b>
Fluted Wood	60	<b>Contact</b>	<b>116</b>
Barley Twist Wood	61		





# Introduction

Founded in London 1991 by Shona McKinney, McKinney & Co have long been established as one of the UK's leading and most trusted designers of window furniture. Gracing the world's finest homes and prestigious buildings including Buckingham Palace and 10 Downing Street, our clientele includes Royalty and A-list celebrities.

All products in the bespoke McKinney & Co range are made to order in the UK by local craftspeople using traditional methods, therefore many of the designs can be adapted to clients' specific requirements and special commissions are welcomed.

Alongside finials and specialist brackets McKinney & Co offer in depth advice on all types of curtain poles including complex curved and angled bay windows. Made to measure pelmets and custom finished coronas are also a speciality.





# The London Collection

If London neighbourhoods were colours... McKinney & Co unveils the London Collection composed of Curtain Poles, Finials, Rings & Brackets in a bright & joyful palette of powder coated colours. A love letter to London and its vivid & eclectic boroughs. Bespoke RAL colours & sizes available.





Featured products:  
The London Collection - Richmond

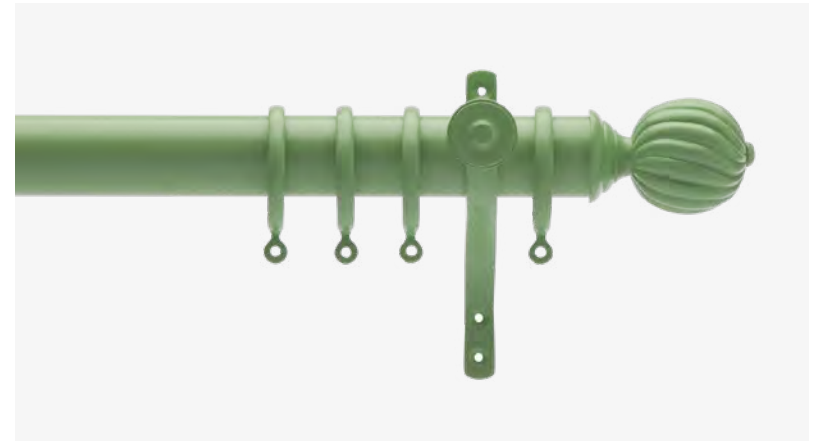

**Richmond**  
P19 - 38mm Metal Pole  
F40 - Metal Finials  
R22 - 51mm Solid Metal Rings  
B5 - Metal Architrave Brackets



**Barbican**  
P19 - 25mm Metal Pole  
F29 - Metal Plain Ball End Finials  
R22 - 38mm Solid Metal Rings  
B5 - Metal Architrave Brackets





**Brixton**

- P19 - 32mm Metal Pole
- F29 - Plain Ball End Metal Finials
- R22 - 45mm Solid Metal Rings
- B5 - Metal Architrave Brackets



**Mayfair**

- P19 - 19mm Metal Pole
- F240 - Metal End Disc Finials
- R22 - 22mm Solid Metal Rings
- B5 - Metal Architrave Brackets with Flat Small Facing



Featured products:  
The London Collection - Brixton





Featured products:  
The London Collection - Notting Hill

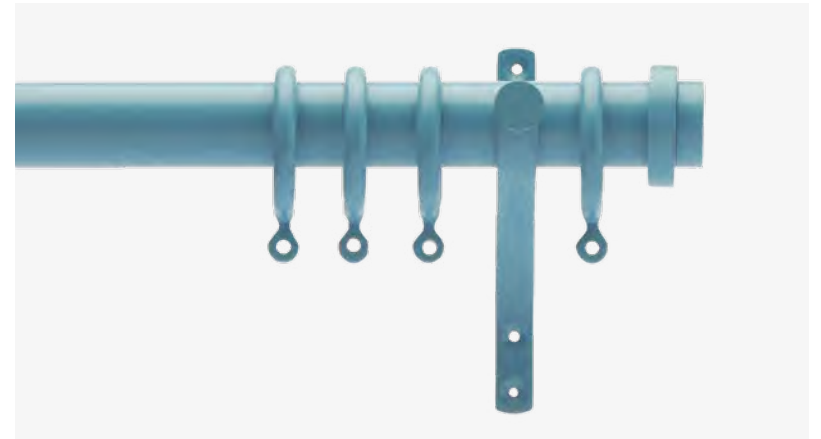

**Notting Hill**

- P19 - 32mm Metal Pole
- F311 - Metal Stepped End Finials
- R22 - 45mm Solid Metal Rings
- B5 - Metal Architrave Bracket with Flat Small Facing



**Oxford Circus**

- P19 - 38mm Metal Pole
- F40 - Metal Finials
- R22 - 51mm Solid Metal Rings
- B5 - Metal Architrave Brackets





# The Steel Collection

We have a wide range of solid metal curtain poles in 16mm, 20mm and 25mm diameter with finials, rings, brackets, and tiebacks to suit. Products from our Steel Collection are waxed or painted and the finishes available are Black Iron, Metallic Black, Burnished steel, Antiqued Brass and Hammered Brass. Bay poles are also available in all the finishes and diameters. Larger diameter poles, special finials, and brackets are also available. We also have rectangular flat poles available as French Return poles or straight poles, please contact us for more information.







Featured products (clockwise from top left):  
MS11A - Architrave Bracket  
MS14 - Extension Bracket  
MS27 - Iron Tree Finial  
MS25 - C Passing Metal Ring  
MS24 - Metal Solid Ring  
MS40 - Square Ended Finial  
MS39 - Round Ended Long Metal Finial  
MS8 - Metal Ball End Finial

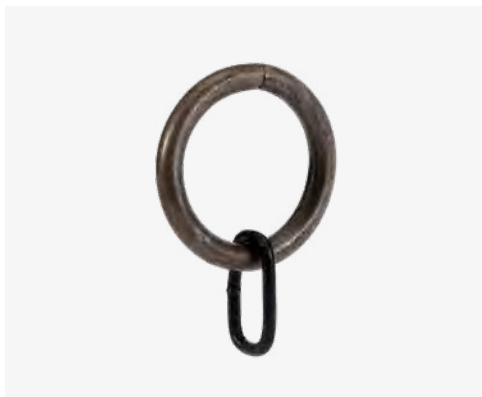

**MS24 - Metal Solid Ring**

Plain metal ring shown in antique brass finish. Available to fit 16mm, 20mm and 25mm diameter solid poles. Other finishes available.

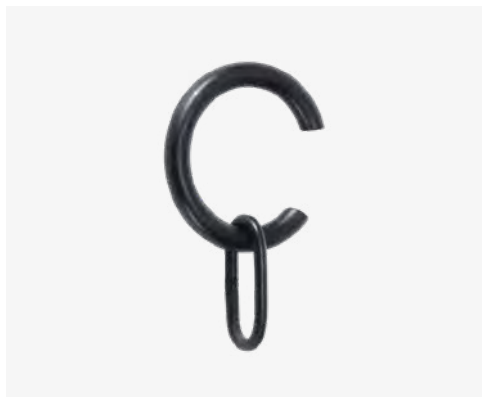

**MS25 - C Passing Metal Ring in Black Iron**

C Passing Metal Ring in Black Iron: C passing plain metal ring in black iron finish.



**MS18 - Talon Metal Finial**

Metal Talon Curtain Pole Finial shown in Black Iron finish on Antiqued Brass pole. Fits a 16mm and 20mm diameter poles. Also available in other finishes.



**MS21 - Trident Metal Finial**

Trident Curtain Pole Finial shown in Antiqued Brass and Black Iron finish. Fits a 16mm and 20mm diameter poles. Also available in other finishes.

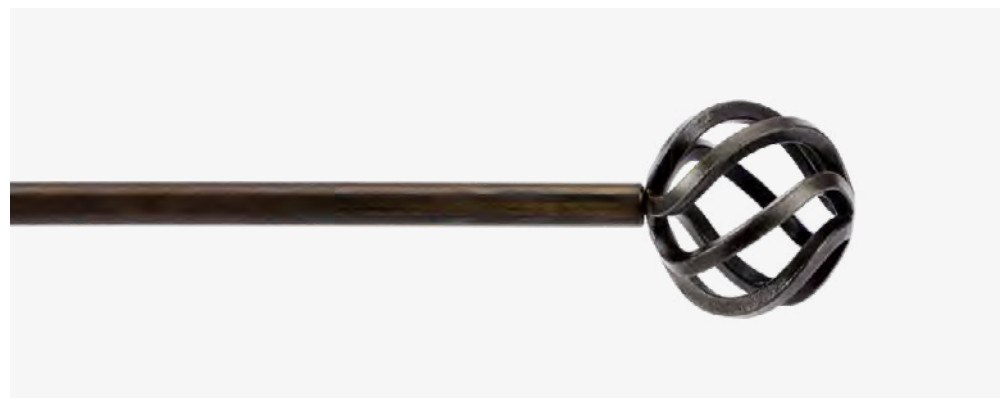

**MS22 - Egg Whisk Metal Finial**

Egg Whisk Metal Curtain Pole Finial shown in Black Iron finish on Antiqued Brass pole. Fits a 16mm and 20mm diameter poles. Also available in other finishes.



**MS26 - Hammered Pole**

Iron Tree Curtain Pole Finial shown in Hammered Antique Brass finish. Fits a 16mm and 20mm diameter poles. Also available in other finishes.



**MS27 - Iron Tree Finial**

Iron Tree Curtain Pole Finial shown in Hammered Antique Brass finish. Fits a 16mm and 20mm diameter poles. Also available in other finishes.



**MS8 - Metal Ball End Finial**

Metal Ball End Curtain Pole Finial shown in Hammered Antiqued Brass finish. Fits a 16mm and 20mm diameter poles. Also available in other finishes.



**MS39 - Round Ended Long Metal Finial**

Round Ended Long Curtain Pole Finial shown in Hammered Antiqued Brass finish. Fits a 16mm and 20mm diameter poles. Also available in other finishes.



**MS40 - Square Ended Finial**

Square Ended Curtain Pole Finial shown in Hammered Antiqued Brass finish. Fits a 16mm and 20mm diameter poles. Also available in other finishes.



**MS41 - Bun Metal Finial**

Bun Curtain Pole Finial shown in Antiqued Brass finish. Fits a 16mm and 20mm diameter poles. Also available in other finishes.



**MS42 - Four Clover Metal Finial**

Four Clover Curtain Pole Finial shown in Antiqued Brass finish. Fits a 16mm and 20mm diameter poles. Also available in other finishes.



**MS43 - Short Round Ended Metal Finial**

Short Round Ended Curtain Pole Finial shown in Hammered Antiqued Brass finish. Fits a 16mm and 20mm diameter poles. Also available in other finishes.





**MS11 - Black Iron Architrave Bracket**

This face fixed black iron bracket has been made using traditional hot forging blacksmithing techniques to create a unique piece. It comes with a strong vertical back plate to support the pole at different heights and it fits solid poles 16mm, 20mm and 25mm in diameter. Available finishes are: Hammered Brass, Stainless Steel, Antiqued Brass, Metallic Black and Burnished Steel.



**MS11 - Black Iron Centre Bracket**

This centre black iron bracket has been made using traditional hot forging blacksmithing techniques to create a unique piece. It comes with a more discreet back plate and it fits solid poles 16mm, 20mm and 25mm in diameter. Available finishes are: Hammered Brass, Stainless Steel, Antiqued Brass, Metallic Black and Burnished Steel.



**MF36 - Metal End Cap**

Square Ended Metal End Cap shown in Hammered Antiqued Brass finish. Fits a 16mm and 20mm diameter poles. Also available in other finishes.





**MS12 - Antique Brass Architrave Bracket**

This face fixed antique brass bracket has been made using traditional hot forging blacksmithing techniques to create a unique piece. It comes with a strong vertical back plate to support the pole at different heights and it fits solid poles 16mm, 20mm and 25mm in diameter. Available finishes are: Hammered Brass, Stainless Steel, Antiqued Brass, Metallic Black and Burnished Steel.



**MS14 - Antique Brass Extension Brackets**

These face fixed and centre antique brass brackets have been made using traditional hot forging blacksmithing techniques to create a unique piece. The face fixed bracket comes with a strong vertical back plate to support the pole at different heights and the centre bracket with a horizontal back plate. It fits solid poles 16mm, 20mm and 25mm in diameter. Available finishes are: Hammered Brass, Stainless Steel, Black Iron, Metallic Black and Burnished Steel.





**MF1 - Antique Brass Bracket with Round Domed Facing**

This face fixed antique brass bracket and round domed facing have been made using traditional hot forging blacksmithing techniques to create a unique piece. It comes with a strong vertical back plate to support the pole at different heights and it fits solid poles 16mm, 20mm and 25mm in diameter. Available finishes are: Hammered Brass, Stainless Steel, Antiqued Brass, Metallic Black and Burnished Steel.



**MF2 - Antique Brass Bracket with Square Facing**

This face fixed antique brass bracket and square facing have been made using traditional hot forging blacksmithing techniques to create a unique piece. It comes with a strong vertical back plate to support the pole at different heights and it fits solid poles 16mm, 20mm and 25mm in diameter. Available finishes are: Hammered Brass, Stainless Steel, Antiqued Brass, Metallic Black and Burnished Steel.



**MF3 - Black Iron Bracket with Hammered Flat Disc Facing**

This face fixed black iron bracket and flat disc facing have been made using traditional hot forging blacksmithing techniques to create a unique piece. It comes with a strong vertical back plate to support the pole at different heights and it fits solid poles 16mm, 20mm and 25mm in diameter. Available finishes are: Hammered Brass, Stainless Steel, Antiqued Brass, Metallic Black and Burnished Steel.





# The Café Rods Collection

Our café rods are the perfect solution for voiles and net curtains. They can be used in wardrobes, within the recess of small windows and on decorative panels. They come in 12mm, 16mm and 19mm diameter hollow brass with a considerable range of socket and end brackets and are available in a variety of finishes.





**A21 - Portiere Rod**

Metal pole 15mm in diameter with solid brass brackets, rings and fittings shown in Antiqued Brass finish. Portiere rods are designed to be fitted over doors with the long bracket on the door and the shorter bracket on the door jamb. When the door is opened the rod is lifted slightly to raise the curtain off the floor to stop it catching and dragging under the door. Other finishes available.





**Café Rod**

16mm Café Rod in light crank and socket.

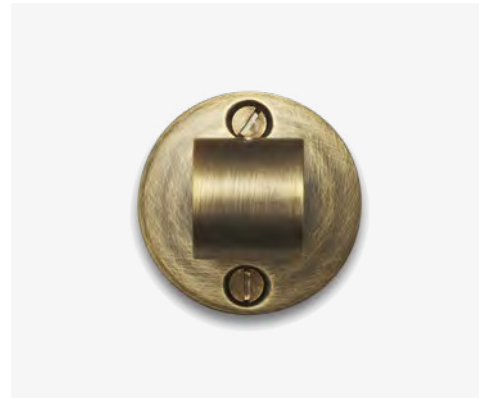

**Ring Bracket**

Ring Bracket with round backplate.

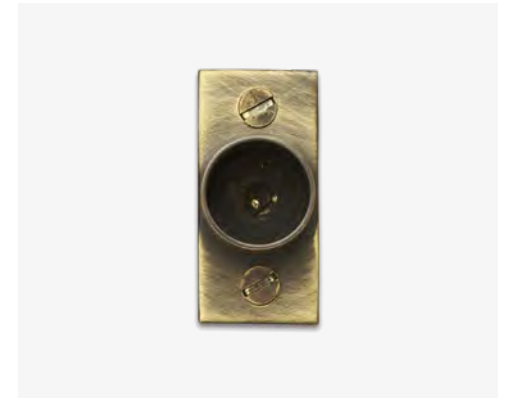

**Light End Socket**

Simple crank socket.

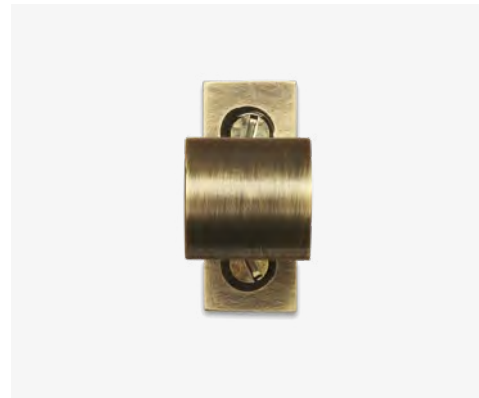

**Ring Bracket**

Ring Bracket with rectangular backplate.



**Café Rod**

16mm Café Rod in round socket.



**Solid Rod**

19mm Solid Rod with rope ring bracket with rectangular backplate.



**Ring Bracket**

Ring Bracket with rectangular backplate.



**End Caps**

Availbale in 12mm, 16mm and 19mm diameter and with grub screw to secure pole in place.

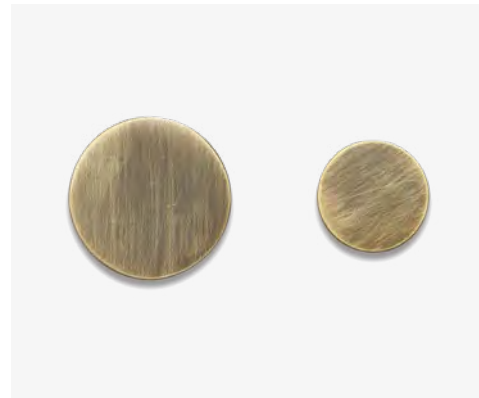

**Flat Discs**

Flat End Discs availbale in 12mm, 16mm and 19mm diameter.



**Café Rod**

19mm Café Rod with rope ring bracket and round backplate.



# The McKinney Collection

The McKinney Collection aims to provide an essential range of high-quality curtain pole sets and accessories, perfect for uncomplicated windows. Pole sets (except 35mm Perspex) are available in either 2m or 2.5m lengths and come with appropriate number of brackets and rings. Poles can be cut down to exact sizes at a fixed cost of £15.00 per pole. All Perspex poles are to have centre brackets. Brackets are supplied in either Antiqued Brass or Polished Nickel.





**Antiqued Brass Curtain Pole Set**  
38mm diameter

Finial: 38mm/1.5"  
L: 9cm/3.5"  
W: 8cm/3"  
B: 5cm/2"

**2m    £438.00**  
**2.5m    £486.00**

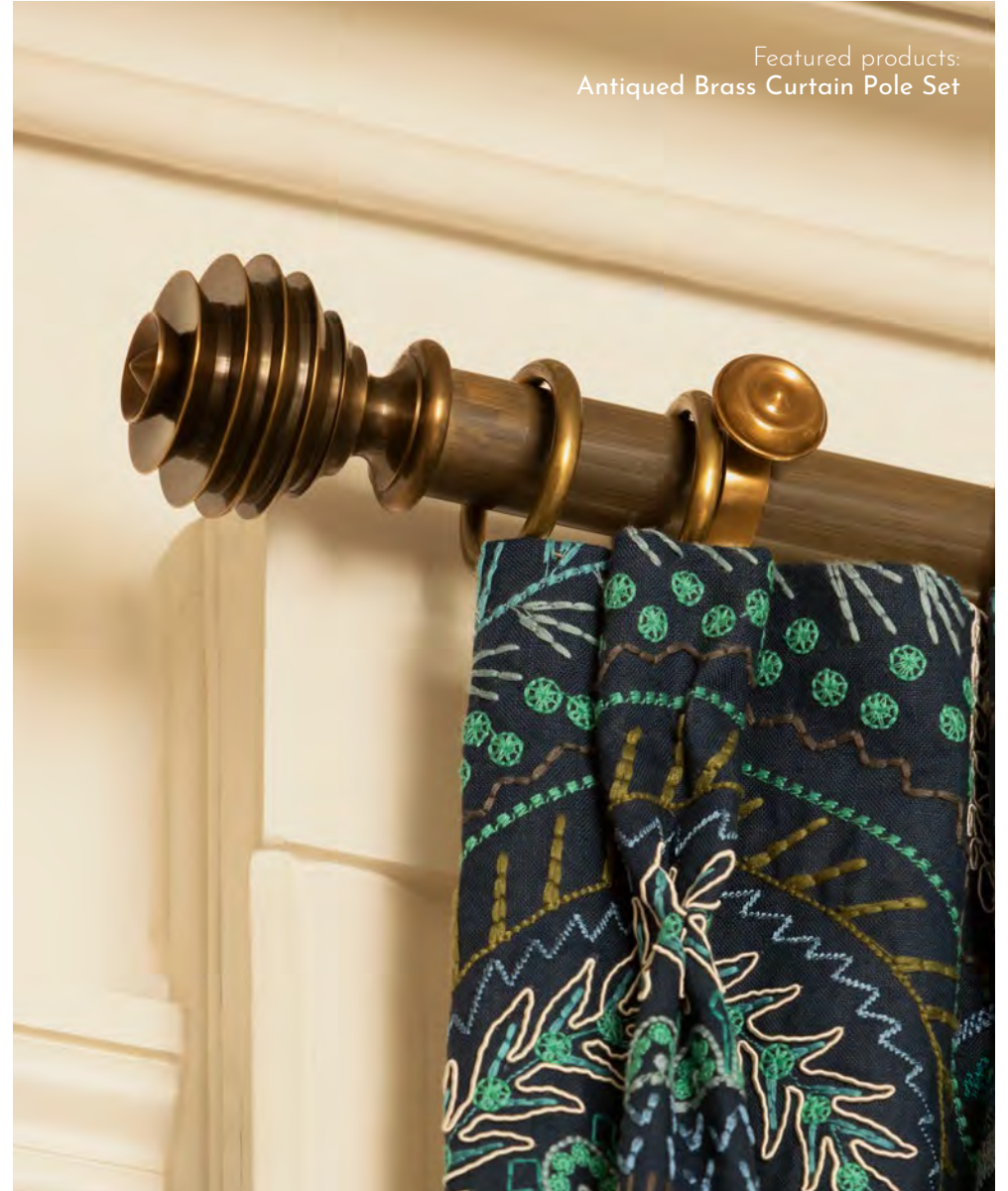

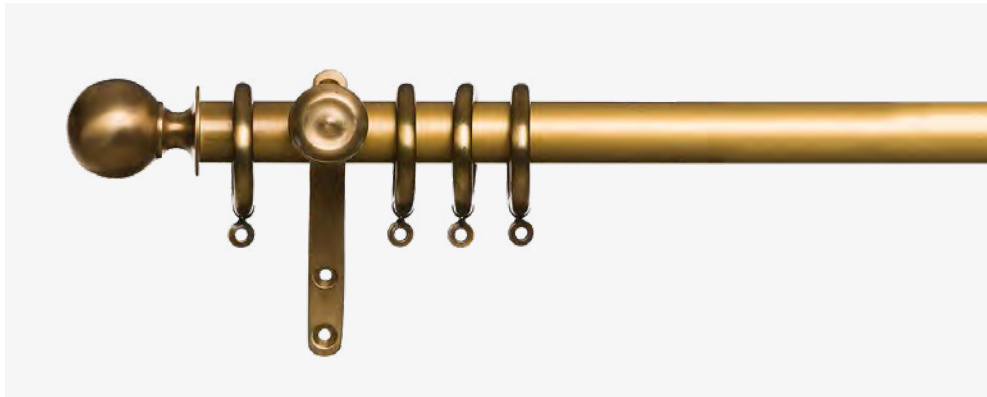

**Antiqued Brass Curtain Pole Set** 25mm diameter

Finial: 25mm/1" | L: 5.5cm/2.25" | W: 4cm/1.5" | B: 4cm/1.5"

2m **£299.00** | 2.5m **£360.00**

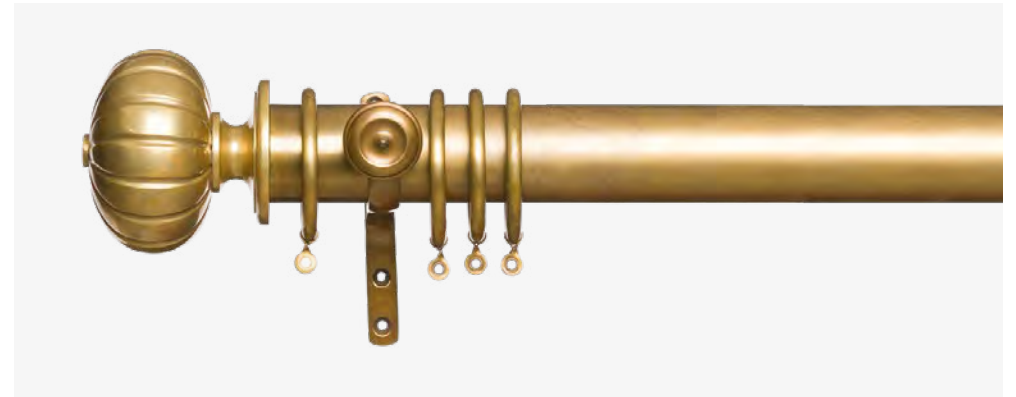

**Antiqued Brass Curtain Pole Set** 51mm diameter

Finial: 51mm/2" | L: 10cm/4" | W: 10.5cm | B: 7.5cm/3"

2m **£568.00** | 2.5m **£594.00**



**Black Wrought Iron Painted Curtain Pole Set** 16mm diameter

Finial: 3mm/1.25" | L: 9cm/3.5" | W: 2cm/0.75" | B: 5cm/2"

2m **£310.00** | 2.5m **£385.00**



**Antiqued Nickel Curtain Pole Set** 38mm diameter

Finial: 38mm/1.54" | L: 7cm/2.75" | W: 5.5cm/2.25" | B: 5cm/2"

2m **£478.00** | 2.5m **£525.00**



Dark Stain Wood Curtain Pole Set 51mm diameter

Finial: 51mm/2" | L: 10cm/4" | W: 7.5cm/3" | B: 6cm/2.25"

2m **£336.00** | 2.5m **£404.00**



Dark Stain Wood Curtain Pole Set 63mm diameter

Finial: 63mm/2.5" | L: 14cm/5.5" | W: 9.5cm/3.75" | B: 7.5cm/3"

2m **£486.00** | 2.5m **£544.00**



Wood Resin Imitation Gilt Curtain Pole Set 51mm diameter

Finial: 51mm/2" | L: 11cm/4.5" | W: 7.5cm/3" | B: 7cm/2.75"

2m **£533.00** | 2.5m **£568.00**



Gilded Wood Curtain Pole Set 51mm diameter

Finial: 51mm/2" | L: 14cm/5.5" | W: 9.5cm/3.75" | B: 7cm/2.75"

2m **£448.00** | 2.5m **£508.00**



Light Satin Wood Curtain Pole Set 51mm diameter

Finial: 51mm/2" | L: 10cm/4" | W: 7.5cm/3" | B: 6cm/2.25"

2m **£332.00** | 2.5m **£394.00**

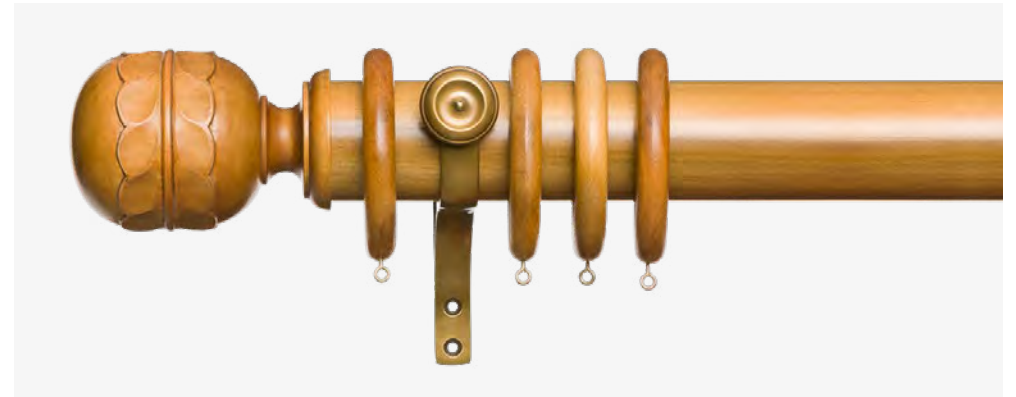

Light Satin Wood Curtain Pole Set 63mm diameter

Finial: 63mm/2.5" | L: 14cm/5.5" | W: 9.5cm/3.75" | B: 7.5cm/3"

2m **£464.00** | 2.5m **£520.00**

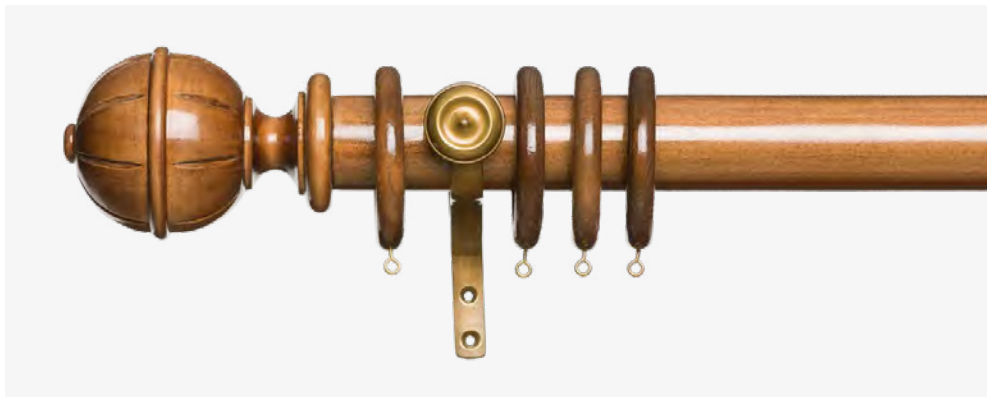

High Gloss Wood Curtain Pole Set 51mm diameter

Finial: 51mm/2" | L: 7cm/2.75" | W: 14cm/5.5" | B: 10cm/5"

2m **£422.00** | 2.5m **£508.00**



Painted White Wood Curtain Pole Set 38mm diameter

Finial: 38mm/1.5" | L: 11cm/4.25" | W: 7cm/2.75" | B: 6cm/2.25"

2m **£448.00** | 2.5m **£508.00**



Perspex Curtain Pole Set with Glass Finial

Finial: 35mm/2.5" | L: 11cm/4.25" | W: 8cm/3" | B: 8cm/3"

35mm - 2m **£393.00**

50mm - 2m **£566.00** | 2.5m **£642.00**

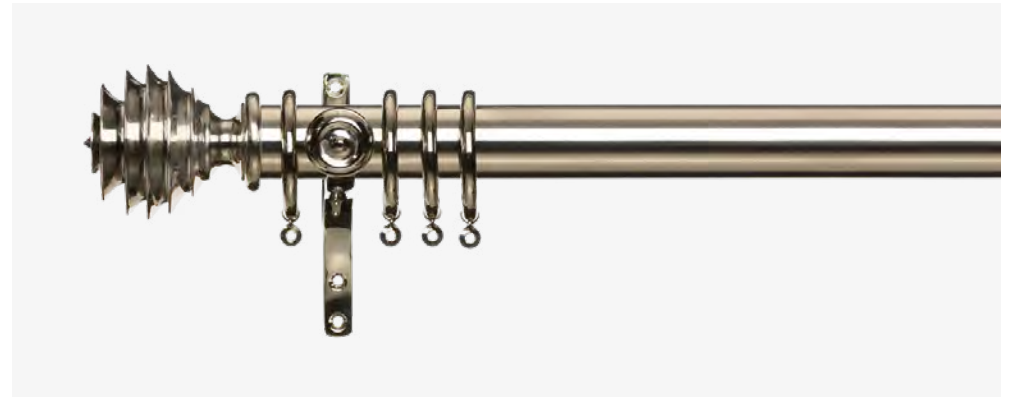

Polished Nickel Curtain Pole Set 38mm diameter

Finial: 38mm/1.5" | L: 9cm/3.5" | W: 8cm/3" | B: 5cm/2"

2m **£460.00** | 2.5m **£522.00**



Polished Nickel Curtain Pole Set 51mm diameter

Finial: 51mm/2" | L: 10cm/4" | W: 10.5cm | B: 7.5cm/3"

2m **£460.00** | 2.5m **£522.00**





# Finials

We have been producing the widest range of beautifully made bespoke & customised curtain pole finials in Great Britain for over 30 years. Our aim is to provide our customers a springboard for your own creativity. With hundreds of finial styles, shapes & sizes to choose from, every finial is custom finished to your specifications, allowing you the opportunity to create a truly individual finial, if you can't find a piece that suits your purpose, we are more than happy to create one for you. Below we are only showing a small selection of our finials to whet the appetite please contact us to find out more.

- |                     |   |                            |   |
|---------------------|---|----------------------------|---|
| <b>Classical</b>    | > | <b>Spherical</b>           | > |
| <b>Heritage</b>     | > | <b>Square</b>              | > |
| <b>Modern</b>       | > | <b>Glass &amp; Perspex</b> | > |
| <b>Eclectic</b>     | > | <b>Metal</b>               | > |
| <b>Naturalistic</b> | > | <b>End Caps</b>            | > |



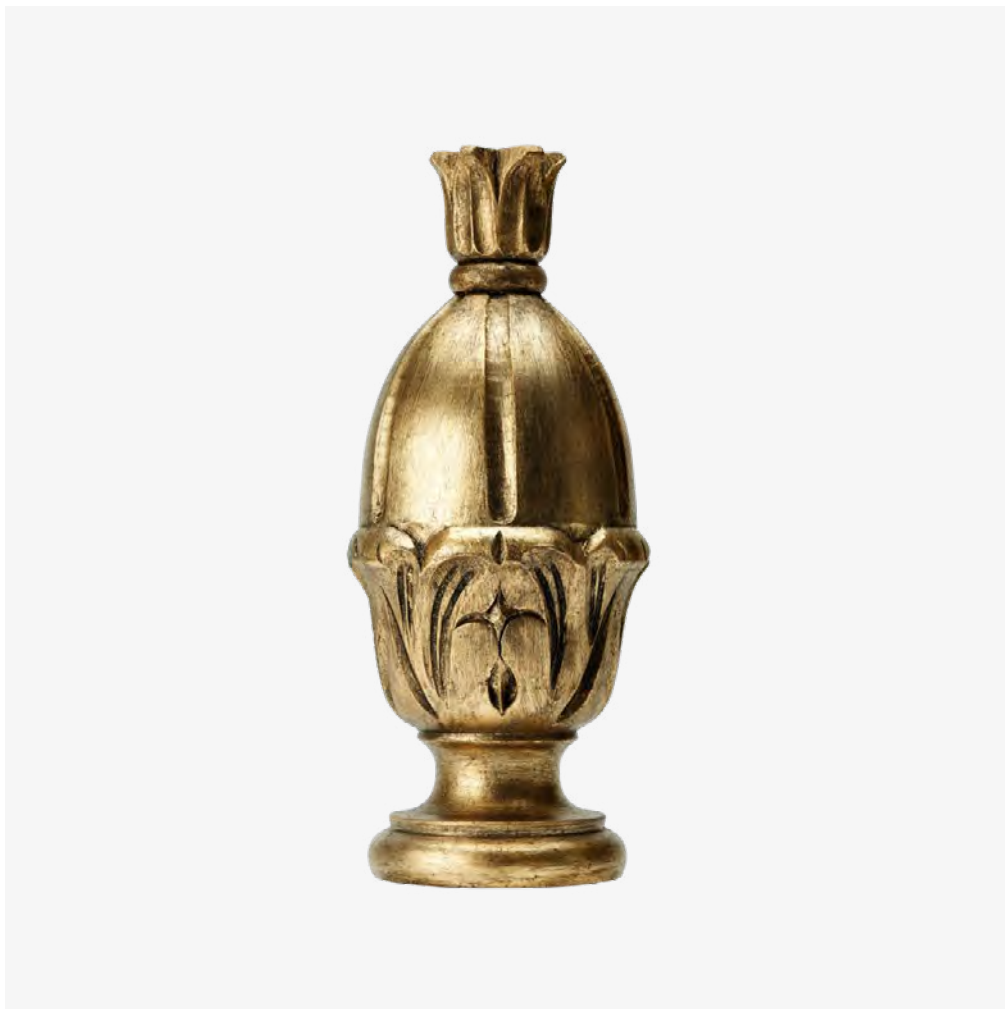

**F28 - Stylised Pineapple**

Wood Stylised Pineapple Curtain Pole Finial shown in BC Gold Imitation Gilt.  
Fits a 51mm and 63mm diameter poles.  
Also available in other finishes.



Featured products:  
F23 - Fluted Cone Wood Finial  
F28 - Stylised Pineapple Finial  
F179 - Gothic Finial





**F1 - Coronet**

Coronet Curtain Pole Finial shown in 38mm diameter size in LA Gold Imitation Gilt finish. Fits 38mm and 51mm diameter poles. It can be made in resin and wood and there are also more finishes available.



**F3 - Ribbed Cone**

Ribbed Cone Wood Curtain Pole Finial shown in stain #2 finish. Fits a 51mm diameter pole. Also available in other finishes.



**F10 - Ribbed Classic Bun Wood**

Ribbed Classic Bun Wood Curtain Pole Finial shown in 51mm diameter in #12R Stain Wood finish. Fits a 38mm, 51mm, 63mm and 76mm diameter poles. Also available in all metal, wood with metal (FIOM) and in other finishes.



**F11 - Classical Urn**

Image shows 76mm diameter wood in Antique Pewter Imitation Gilt finish. Fits a 38mm, 51mm, 63mm and 76mm diameter poles. It comes in wood and resin and is also available in other finishes.

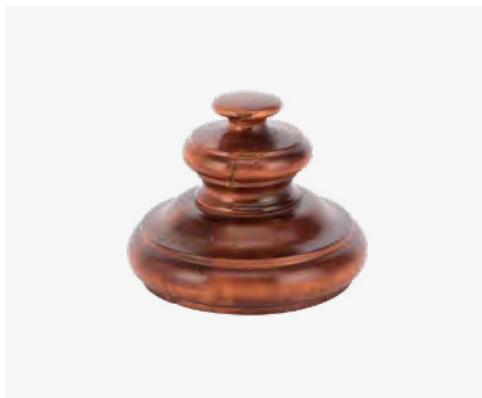

**F12 - Turned Bulb Wood**

Turned Bulb Wood Curtain Pole Finial shown in Stain #25. Fits a 38mm and 51mm diameter poles. Also available in other finishes.



**F23 - Fluted Cone Wood Finial**

Fluted Cone Wood Curtain Pole Finial shown in 51mm diameter and in stain #22 wood finish. Fits a 51mm and 63mm diameter poles. Also available in other finishes.



**F24 - Wood Classic Acorn**

Wood Classic Acorn Curtain Pole Finial shown in 63mm diameter in 2 colour stains, top in #23 and base in #12 wood finishes. Fits a 38mm, 51mm and 63mm diameter poles. Also available in other finishes.

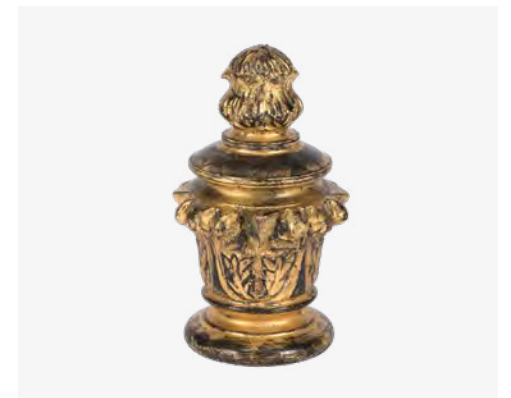

**F25 - Flambeau**

Flambeau Wood Curtain Pole Finial shown in 63mm diameter in AA watergilt finish. Fits a 51mm and 63mm diameter poles. Also available in resin and in other finishes.





**F43 - Bobble Wood**

Two available sizes, the 51mm in Stain #40 finish and the 38mm in BC Gold Imitation Gilt. Fits 38mm and 51mm diameter poles. It can be made in resin and wood and there are also more finishes available.

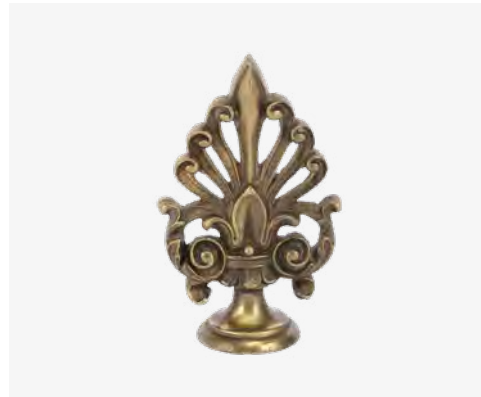

**F76 - Metal Acanthus**

Metal Acanthus Curtain Pole Finial shown in Antique Brass finish. Fits a 38mm diameter pole. Also available in other finishes.



**F94 - Resin**

Resin Curtain Pole Finial shown in AL Gold Imitation Gilt finish. Fits a 51mm diameter pole. Also available in other finishes.



**F108 - Royal Flower**

Royal Flower Wood Curtain Pole Finial shown in Wood in AF Silver Watergilt Finish. Fits a 51mm diameter pole. It can also be made in resin and there are other finishes available.



**F131 - Ribbed Urn**

Ribbed Urn Curtain Pole Finial shown in resin in EC Gold Imitation Gilt finish. Fits a 38mm diameter pole. It can be made in resin and wood and there are also more finishes available.



**F136 - Ribbed Pumpkin**

Resin Ribbed Pumpkin Curtain Pole Finial shown in 51mm diameter in NV2 dirty varnish paint finish. Fits a 51mm and 63mm diameter poles. Also available in wood and other finishes.



**F139 - Reed Bobble Cup**

Reed Bobble Cup Resin Curtain Pole Finial shown in KA Gold Imitation Gilt finish. Fits a 51mm diameter pole. Also available in other finishes.



**F143 - Swirl Hazelnut**

Swirl Hazelnut Curtain Pole Finial shown 51mm diameter in KA Gold Imitation Gilt finish. Fits a 51mm and 63mm diameter poles. It can be made in resin for 63mm diameter size and in wood for both sizes. There are also more finishes available.



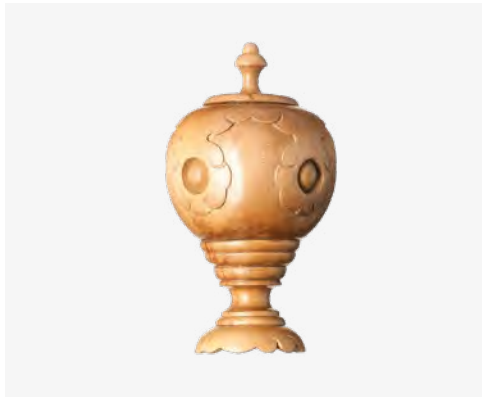

**F265 - Moroccan Urn Wood**

Moroccan Urn Wood Curtain Pole Finial shown in Stain Light Oak. Fits a 51mm and 63mm diameter pole. Also available in resin and in other finishes.



**F270 - Decorative Fleur De Lys**

Resin Fleur De Lys Curtain Pole Finial shown in YG Gold Imitation Gilt Finish. Fits a 51mm diameter pole. Also available in other finishes.

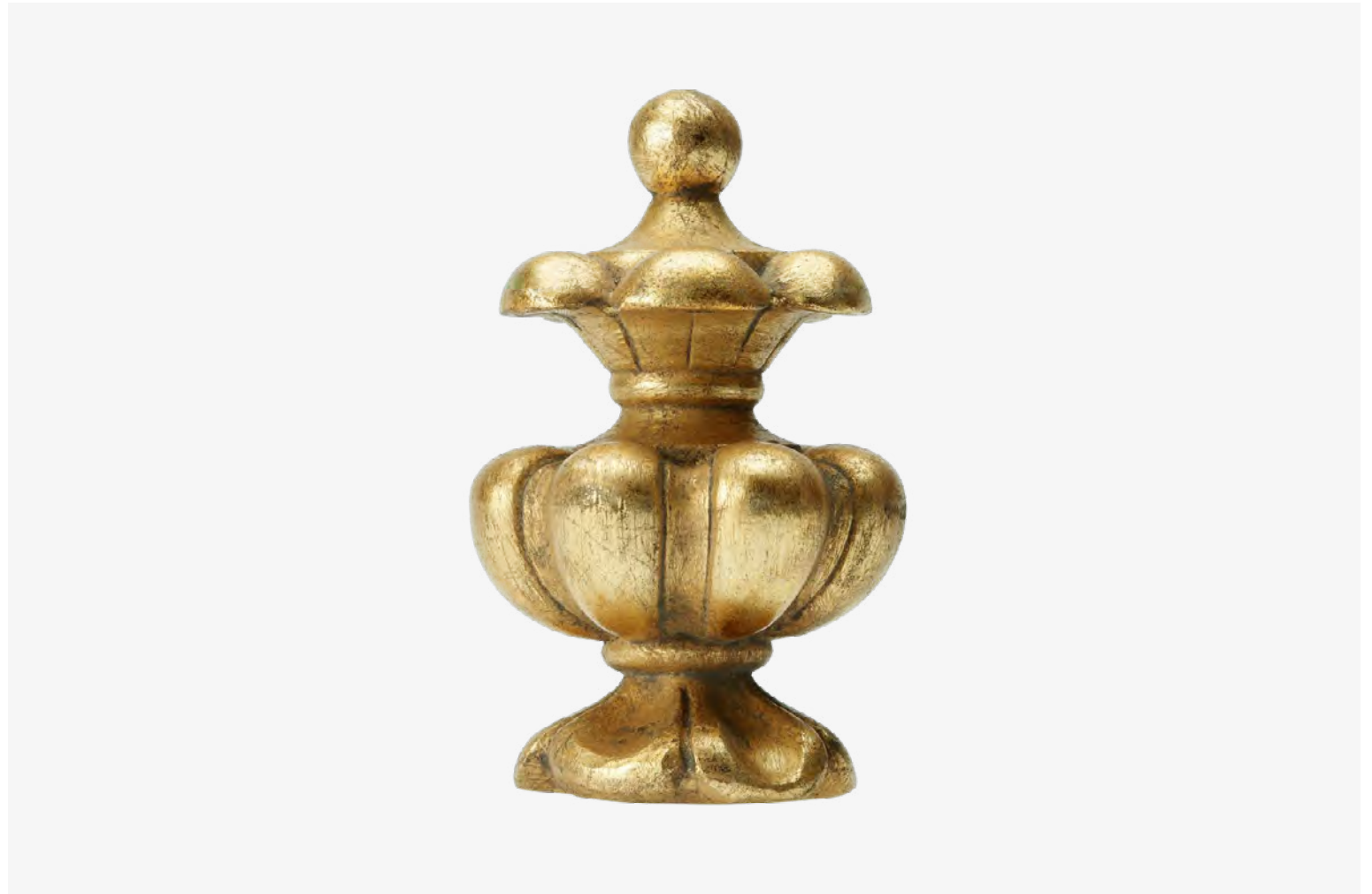

**F310 - Decorative**

Decorative Wood Curtain Pole Finial shown in BC Gold Imitation Gilt Finish on main image and also shown in the 2 available sizes. It can also be made in resin for painted and gilded options. Fits a 38mm and 63mm diameter poles. Also available in other finishes.





Featured products:  
F98 - Reeded Antique Brass Pole  
F4 - Pineapple Finial, with F4 - Fluted Wood Pole

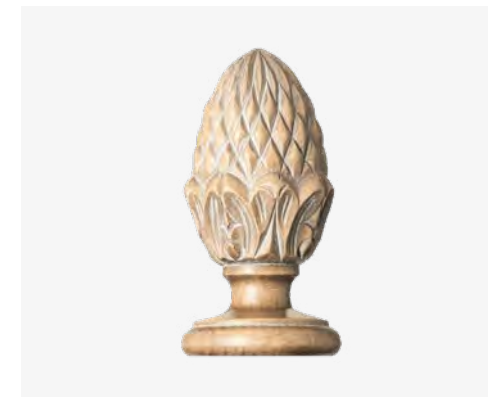

**F4 - Pineapple**

Pineapple Curtain Pole Finial shown on first image 51mm diameter Wood in Limed Wood finish. Fits a 38mm, 51mm, 63mm and 76mm diameter poles. Also available in other finishes.

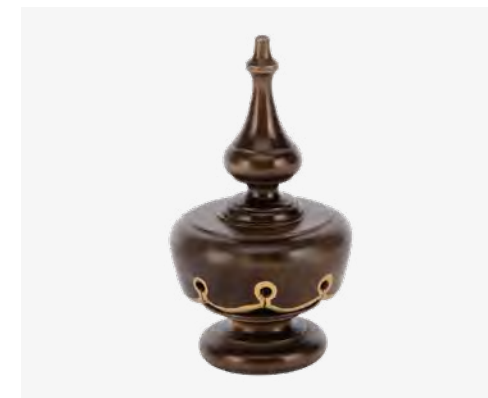

**F22 - Gothic Wood**

Gothic Wood Curtain Pole Finial shown in main image 63mm diameter in stain #35 wood finish. Fits a 38mm, 51mm and 63mm diameter poles. The 38mm diameter finial can be made in resin. Also available in other finishes.



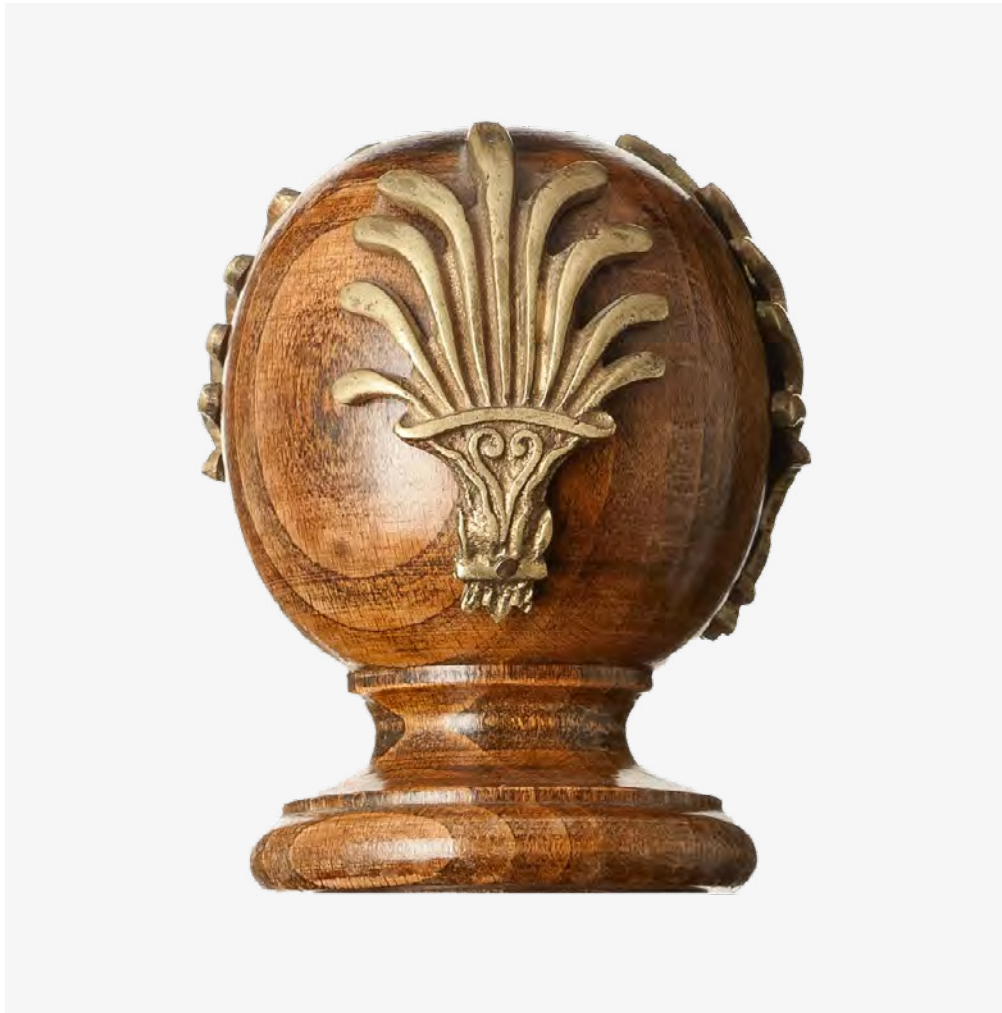

**F38 - Heraldic Claws**

Heraldic Metal Claws on Wood Curtain Pole Finial shown in stain #22 wood finish with antiqued brass claws. Fits a 51mm diameter pole. Also available in other finishes.



**F74 - Small Pineapple with Leaves**

Small Pineapple with Leaves Metal Pole Finial shown in 51mm diameter in Antique Brass finish. Fits with the leaves a 51mm diameter pole and without the leaves a 25mm pole. Also available in other finishes.



**F78 - Ribbed Skirt**

Ribbed Skirt Wood Curtain Pole Finial shown in #12R Stain Wood finish. Fits a 51mm diameter pole. Also available in other finishes.



**F83 - Arabian Bobble**

Arabian Bobble Resin Curtain Pole Finial shown in BK gold imitation gilt finish. Fits a 51mm and 63mm diameter pole. Also available in other finishes.

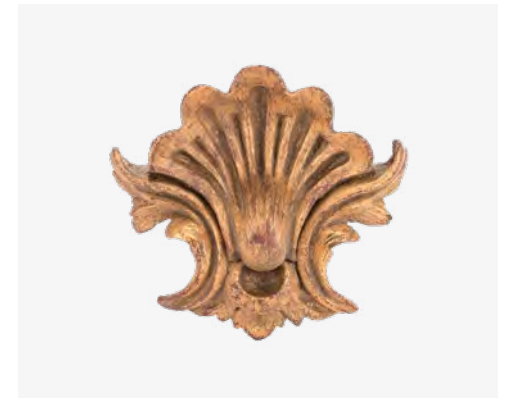

**F90 - Resin Shell**

Resin Shell Curtain Pole Finial shown in DMR Gold Imitation Gilt Finish. Fits a 51mm diameter pole and it has a flat back. Also available in other finishes.





**F97 - Fluted Bun**

Fluted Bun Wood Curtain Pole Finial shown in 51mm diameter in Stain #12 with rubbed off gilt detail and on second image shown 76mm diameter in SA Silver Imitation Gilt finish. Fits a 51mm, 63mm and 76mm diameter poles. Also available in other finishes.



**F144 - Swirl Bun**

Swirl Bun Resin Curtain Pole Finial shown in SA silver imitation gilt finish. Fits a 63mm diameter pole. Also available in other finishes.



**F146 - Skirted**

Ribbed Classic Bun Wood Curtain Pole Finial shown in 51mm diameter in #12R Stain Wood finish. Fits a 38mm, 51mm, 63mm and 76mm diameter poles. Also available in all metal, wood with metal (F10M) and in other finishes.



**F242 - Carved Wood**

Wood Carved Curtain Pole Finial shown in GG imitation gilt finish. Fits a 63mm diameter pole. Also available in resin and in other finishes



**F267 - Etruscan Pot**

Etruscan Pot Wood Carved Curtain Pole Finial shown in NW2 Dirty Varnish finish. Fits a 63mm diameter pole. Also available in other finishes



**F268 - Horizontal Grooves Wood**

Horizontal Grooves Wood Curtain Pole Finial shown in stain #12 finish with gilt detail. Fits a 63mm diameter poles. Also available in other finishes.



**F276 - Wood Minaret**

Wood Minaret Curtain Pole Finial shown in AO silver watergilt finish. Fits a 63mm diameter pole. Also available in other finishes.







**F145 - Ribbed Square**

Ribbed Square Finial shown in #40 stain wood finish, 51mm diameter. Fits a 25mm, 38mm, 51mm and 63mm diameter poles. It can be made in wood, resin and metal. Also available in other finishes.



**F148 - Cornered Square**

Cornered Square Curtain Pole Finial shown in 51mm diameter wood in #25 stain finish with edges detail in #16 Ebony stain finish. Fits a 38mm, 51mm and 63mm diameter poles. It can be made in wood, metal and resin.



**F149 - Metal Dome on Wood**

Metal Dome on Wood Curtain Pole Finial shown 63mm diameter in stain #36 with Polished Nickel Dome. Fits a 51mm and 63mm diameter poles. Also available in other finishes.



**F189R - Ribbed Band**

Ribbed Band Finial shown in Solid Oak and Polished Nickel finish. Fits a 63mm diameter pole. Also available in other finishes.



**F190 - Clear Glass & Metal**

Clear Solid Glass Ball Finial shown is 63mm diameter size in Clear Glass and Polished Nickel Top and Base. Fits a 63mm diameter pole. Also available in frosted glass and other metal finishes.



**F190 - Antique Gilt**

Image shows 51mm diameter size in Clear Glass and Antique Brass Top and Base. Fits a 51mm diameter pole. Also available in frosted glass and other metal finishes.



**F191 - Modern Sphere**

Modern Sphere Metal and Perspex Curtain Pole Finial shown in Polished Nickel/Clear Perspex and Antiqued brass/Clear Perspex. Fits a 38mm, 51mm and 63mm diameter pole. Also available in other finishes.



**F202 - Cage**

Cage Finial shown in Polished Nickel finish with clear solid glass ball. Fits a 51mm diameter pole. Also available in wood and other finishes.





**F207 - Classic Cylinder**

Classic Cylinder Finial shown in stain #36 and Antique Brass finish. Fits a 38mm, 51mm and 63mm diameter poles. Also available in other finishes.



**F233 - Wood & Metal**

Wood and Metal Curtain Pole Finial shown in wood stain #16 Ebony and Polished Nickel finish. Fits a 63mm diameter pole. Also available in other finishes.



**F249 - Cylinder**

Stripped Cylinder Finial shown in Polished Nickel finish and dark stain wood. Fits a 51mm diameter pole. Also available in other finishes.



**F271 - Flat Metal Topped Cylinder**

Flat Metal Topped Cylinder Finial shown in Polished Nickel finish and Wood stained #7. Fits a 51mm and 63mm diameter poles. Also available in other finishes.



**F298 - Flat Top Wooden**

Flat Top Wooden Finial shown in High Gloss Ebony finish. Fits a 63mm diameter pole. Also available in other finishes.



**F304 - Flat Metal Top**

Flat Metal Top and Wood Finial shown in Antique Gilt metal finish and #16 Ebony Stain finish. Fits a 63mm diameter pole. Also available in other finishes.



**F305 - Flat Wood Top**

Flat Top Wooden Finial shown in Stain Ebony and Antique Gilt finish. Fits a 63mm diameter pole. Also available in other finishes.





**F8 - Metal Glass Sandwich**

Metal & Glass Sandwich Curtain Pole Finial shown in Antiqued Brass and Clear Glass. Fits a 51mm and 63mm diameter poles. Also available in other finishes.

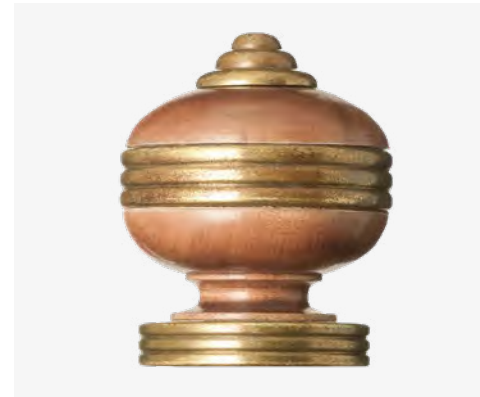

**F10 - Ribbed Classic Bun**

Ribbed Classic Bun Curtain Pole Finial shown in 63mm diameter Antiqued brass and Wood Stained #22 finish. Fits a 51mm and 63mm diameter pole. Also available in all wood (F10), all metal and in other finishes.



**F38 - Heraldic Claws**

Heraldic Claws Wood and Metal Curtain Pole Finial shown in a stain finish with antiqued brass claws. Fits a 51mm diameter pole. Also available in other finishes.



**F57 - Ribbed Cone**

Ribbed Cone Curtain Pole Finial shown in 63mm diameter in Polished Nickel and Wood Stained #16-Ebony finish. Available in all metal to fit 38mm, 51mm, and 63mm diameter poles. In all wood to fit 38mm, 51mm, 63mm and 76mm diameter poles. And in wood and metal to fit 63mm diameter pole. Also available in other finishes.

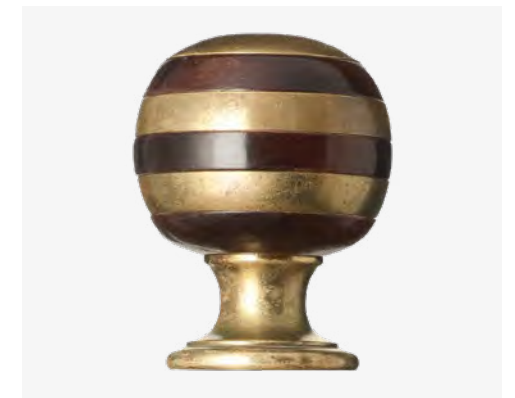

**F134 - Sliced Ball**

Sliced Ball Finial in Metal and Wood shown in 63mm diameter in Antiqued brass and Wood stained #25 High polish finish. The metal and wood parts can be swapped around F134M has a metal base and F134W has a wooden base, please specify when ordering. Fits a 38mm, 51mm and 63mm diameter pole. Also available in other finishes.





**F134 - Sliced Ball**

Sliced Ball Finial in Metal and Wood shown 51mm diameter in Polished Nickel and Wood in stain #12 finish. The metal and wood parts can be swapped around F134M had a metal base and F134W has a wooden base, please specify when ordering.



**F165 - Wood & Glass Stack**

Wood & Glass Stack Curtain Pole Finial shown in Wood Stain #4 finish and Clear Glass Squares. Fits a 51mm diameter pole. Also available in other finishes.



**F171 - Plaited Leather Band on Ball**

Finial shown in 51mm diameter in Medium Oak Stain Wood finish with Purple coloured Plaited Leather. Fits a 51mm and 63mm diameter poles. Also available in other finishes and leather colours.



**F179 - Gothic**

Finial shown in 63mm diameter in Polished Nickel with Tan Leather detail. Fits a 51mm and 63mm diameter poles. Also available in other metal finishes and types of leather.



**F190 - Antique Gilt**

Gothic Curtain Pole Finial shown in 51mm diameter in Polished Nickel with Snakeskin detail. Fits a 51mm and 63mm diameter poles. Also available in other metal finishes and types of leather.



**F212 - Chinese Hat**

Chinese Hat Metal and Perspex Curtain Pole Finial shown in Antique Brass and Clear Perspex. Fits a 51mm diameter pole. Also available in other finishes.



**F243 - Cut Crystal & Metal Cup**

Cut Crystal and Metal Cup Curtain Pole Finial shown in Polished Nickel. Fits a 51mm diameter pole. Also available in resin and other finishes.





**F26 - Round Acanthus Wood**

Round Acanthus Wood Curtain Pole Finial shown in Elephant's Breath paint finish. Fits a 51mm and 63mm diameter poles. Also available in other finishes.



**F31 - Thistle**

Thistle Wood Curtain Pole Finial shown in stain #10 wood finish with gilt detail. Fits a 51mm diameter pole. Also available in other finishes.



**F44 - Flat Leaf**

Flat Leaf Resin Curtain Pole Finial shown in AL gold imitation gilt finish. Fits a 38mm diameter pole. Also available in other finishes.



**F55 - Bobble Palmette**

Bobble Palmette Curtain Pole Finial shown in resin 38mm diameter in LA Imitation Gilt finish. Fits a 38mm and 51mm diameter poles. Available in both wood and resin and also in other finishes.

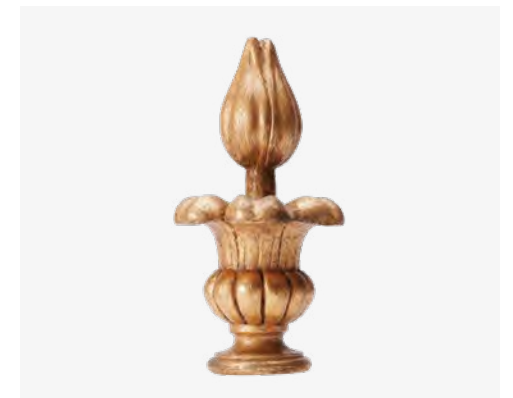

**F64 - Flared Tulip Finial**

Flared Tulip Resin Curtain Pole Finial shown in DM imitation gilt finish. Fits a 38mm and 51mm diameter poles. Also available in other finishes.





**F88 - Pomegranate**

Finial shown in 63mm resin in Light Faux Lime finish. Third image shows 38mm diameter resin in Gold and Silver Custom Imitation Gilt finish. Fits a 38mm, 51mm and 63mm diameter poles. It can be made in resin and wood and there are also more finishes available.



**F110 - Bobble Acanthus**

Bobble Acanthus Resin Curtain Pole Finial shown in GG imitation gilt finish. Fits a 51mm diameter pole. Also available in other finishes.



**F118 - Special Acorn Resin**

Special Acorn Resin Curtain Pole Finial shown in a 3 Custom Colour Paint finish. Fits a 51mm diameter pole. Also available in other finishes.



**F132 - Folly Pineapple**

Folly Pineapple Curtain Pole Finial shown in wood #40 stain finish. Same finial fits a 51mm and 63mm diameter poles. Available in wood and resin and other finishes.



**F137 - Pine Cone**

Pine Cone Curtain Pole Finial shown in 51mm diameter wood in #40 stain finish. Fits a 25mm, 38mm, 51mm and 63mm diameter poles. Available in wood, metal and resin and other finishes.

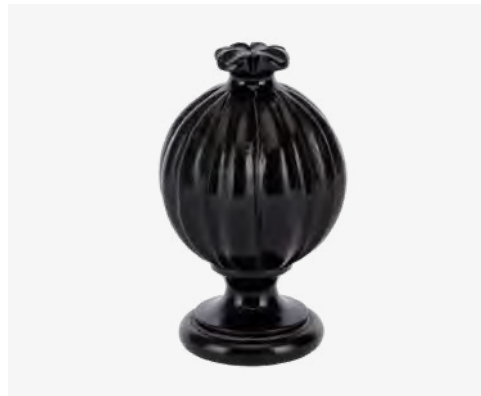

**F140 - Pomegranate without Beads**

Pomegranate Without Beads Wood Curtain Pole Finial shown in #16 Ebony stain finish. Fits a 63mm diameter pole. Also available in other finishes.



**F147 - Acanthus Cup**

Acanthus Cup Curtain Pole Finial shown in 38mm diameter in metal Antiqued Brass finish. Fits a 38mm, 51mm and 63mm diameter poles. It can be made in wood and resin in all 3 sizes and in metal in 38mm and 51mm diameters. Available in other finishes.



**F158 - Flat Leaf**

Flat Leaf Curtain Pole Finial shown in wood #51 stain finish. Fits a 51mm diameter pole. It can be made in wood, resin and metal. Also available in other finishes. Available in other finishes.





**F188 - Double Leaf Metal**

Metal Lily shaped Curtain Pole Finial shown in Antique brass finish. Fits a 38mm diameter pole. Also available in other finishes.



**F193 - Cut Out Orange**

Cut Out Orange Wood Curtain Pole Finial shown in Stain #40 and in the 2 available sizes. Fits a 51mm and 63mm diameter poles. Also available in other finishes.



**F194 - Pine Cone Wood**

Pine Cone Wood Curtain Pole Finial shown in stain #41 Matt finish. Fits a 51mm and 63mm diameter poles. Also available in other finishes.



**F198 - Artichoke**

Artichoke Curtain Pole Finial shown in Custom paint finish. Fits a 51mm diameter pole. It can be made in resin, metal and wood and there are also more finishes available.



**F209 - Wood**

Wood Curtain Pole Finial shown in a stain finish with gold gilt rubbed through. Fits a 63mm diameter pole. Also available in other finishes.



**F278 - Wood**

Wood Curtain Pole Finial shown in a paint and gilt finish. Fits a 51mm diameter pole. Also available in other finishes.



**F279 - Wood Bulb**

Wood Bulb Curtain Pole Finial shown in a paint finish. Fits a 51mm diameter pole. Also available in other finishes.



**F306 - Spiked Cone Wood**

Spiked Cone Wood Curtain Pole Finial shown in a Custom Paint finish. Fits a 51mm diameter pole. Also available in other finishes.



**MS27 - Iron Tree**

Iron Tree Curtain Pole Finial shown in Hammered Antique Brass finish. Fits a 16mm and 20mm diameter poles. Also available in other finishes.





Featured products:  
**F40 - Twister Ball**  
 Polished Nickel Curtain Finial  
**P17 - Polished Nickel**  
 Polished Nickel Curtain Pole 38mm diameter



**F40 - Twisted Ball**

Finial image shows resin 38mm diameter in GG Imitation Gilt finish. Fits a 38mm, 51mm and 63mm diameter poles. It can be made in metal and wood in the 3 sizes, and in resin in 38mm and 51mm diameter sizes. Also available in different finishes.



**F7 - Fluted Wood Ball**

Wood Fluted Ball Curtain Pole Finial shown in 51mm diameter size in BB watergilt finish. Fits a 38mm, 51mm, 63mm and 76mm diameter poles. Also available in other finishes.

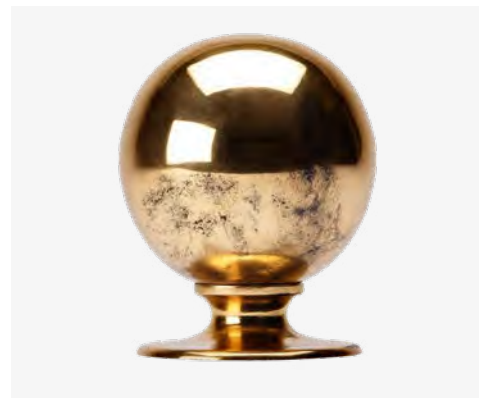

**F29 - Plain Metal Ball**

Plain Metal Ball Curtain Pole Finial shown in 51mm diameter in Antique Gilt finish. A ribbed option also available. Fits a 25mm, 38mm, 51mm, 63mm and 76mm diameter poles. We offer a wood alternative and other finishes too.



**F29 - Plain Wood Ball**

Plain Wood Ball Curtain Pole Finial shown in 51mm diameter in stain #22 wood finish. Fits 38mm, 51mm, 63mm and 76mm diameter poles. Also available in other finishes.





**F29b - Plain Wood Ball with Ribbs**

Plain Wood Ball Curtain Pole Finial shown in 51mm diameter ribbed wood option in stain #25 High Gloss wood finish. Fits 38mm, 51mm, 63mm and 76mm diameter poles. Also available in other finishes.



**F66 - Ribbed Ball**

Ribbed Ball Curtain Pole Finial shown in metal in 51mm diameter in Gun Metal finish. Fits a 38mm, 51mm and 63mm diameter poles. Available with horizontal, vertical and diagonal ribs. Also available in other finishes.



**F120 - Balloon Wood**

Balloon Wood Curtain Pole Finial shown in 51mm diameter resin in AP Silver Imitation Gilt finish. Fits a 51mm and 63mm diameter poles. It can be made in resin and wood and there are also more finishes available.

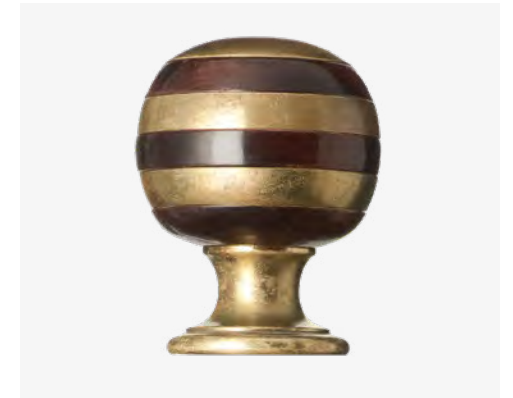

**F134W - Sliced Ball**

Sliced Ball Finial in Metal and Wood shown in 63mm diameter in Antiqued brass and Wood stained #25 High polish finish. Fits a 38mm, 51mm and 63mm diameter pole. Also available in other finishes.



**F134M - Sliced Ball**

Sliced Ball Finial shows 63mm diameter finial on 63mm pole in stain #25 High polish finish. The metal and wood parts can be swapped around F134M has a metal base and F134W has a wooden base, please specify when ordering. Fits a 38mm, 51mm and 63mm diameter pole. Also available in other finishes.



**F135 - Sliced Ball with Perspex**

Sliced Ball with Perspex, Metal and Wood Curtain Pole Finial shown in 63mm diameter in Polished and Unlacquered Brass, Wood in #36 stain finish and Clear Perspex. Fits a 38mm, 51mm and 63mm diameter poles. Also available in other finishes.



**F176 - Wide Layered Birch/Perspex Banded**

Wide Layered Birch and Perspex Banded Curtain Pole Finial. Fits 51mm and 63mm diameter poles. Available in other finishes.



**F177 - Narrow Layered Birch/Perspex Banded**

Narrow Layered Birch and Perspex Banded Curtain Pole Finial. Fits 63mm diameter pole.





**F189 - Modern Ball**

Modern Ball Finial shown in Stain #25 and Antique Brass finish. Fits a 63mm diameter pole. Also available in other finishes.



**F190 - Clear Glass & Metal**

Clear Solid Glass Ball Finial shown is 63mm diameter size in Clear Glass and Polished Nickel Top and Base. Fits a 63mm diameter pole. Also available in frosted glass and other metal finishes.



**F215 - Fine Reeded Ball**

Fine Reeded Ball Wood Curtain Pole Finial shown in 51mm diameter size in NW1 dirty varnish finish. Fits a 38mm, 51mm and 63mm diameter poles. Also available in other finishes.



**F244 - Metal and Perspex Ball**

Metal and Perspex Curtain Pole Finial shown in Antiqued brass, Nickel and Clear Perspex. Fits a 63mm diameter pole. Also available in other finishes.



**F252 - Wood and Metal Sphere**

Wood and Metal Sphere Curtain Pole Finial shown in Antiqued Brass with Stained Wood and Nickel with Petrified Wood effect. Fits a 51mm and 63mm diameter poles. Also available in other finishes.



**F253 - Metal Ball & Wooden Base**

Metal Ball and Wooden Base Curtain Pole Finial shown in Polished Nickel and Wood Stain #16 Ebony. Fits a 63mm diameter pole. Also available in other finishes.

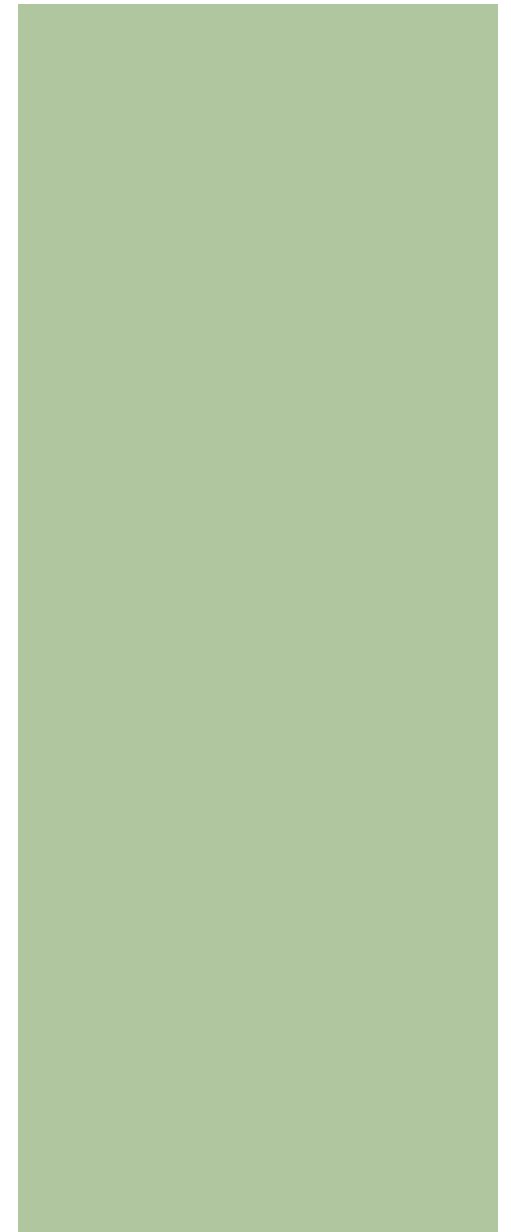



Featured products:  
F106 - Horizontal Fluted Ball



**F106 - Horizontal Fluted Ball**

Horizontal Fluted Ball Wood Curtain Pole Finial shown in 2 Custom paint finishes. Fits a 51mm and 63mm diameter poles. Also available in other finishes.

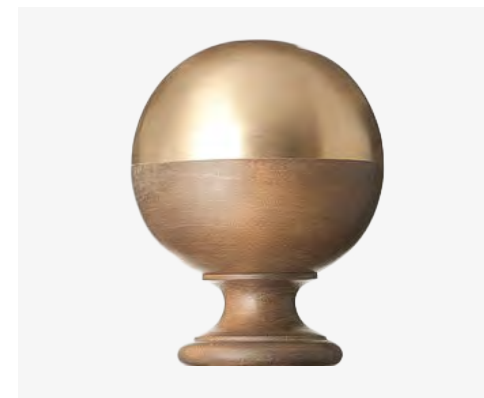

**F254 - Demi Ball**

Demi Ball Curtain Pole Finial shown in Satin Brass and Wood stained #8 matt. Fits a 51mm diameter pole. Also available in other finishes.





**F222 - Square Grooved Wood**

Square Grooved Wood Curtain Pole Finial in Stain #25. Fits a 51mm diameter pole. Also available in other finishes.

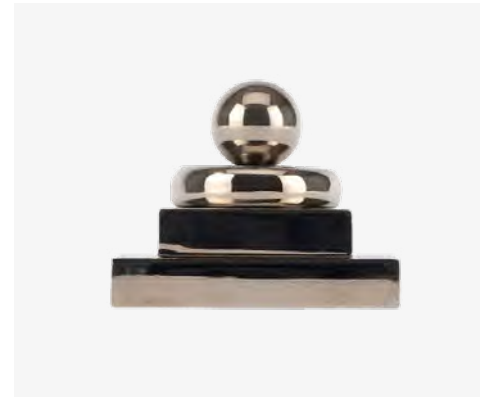

**F226 - Square & Circle Metal with Metal Ball**

Square and Circle Metal with Metal Ball Curtain Pole Finial shown in Polished Nickel finish. Fits a 38mm diameter pole. Also available in other finishes.

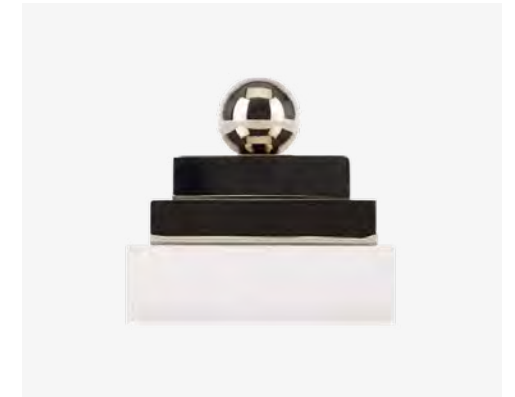

**F227 - Clear Square Perspex & Square Metal**

Square Metal and Perspex Curtain Pole Finial shown in Clear Square Perspex and Polished Nickel finish. Fits a 38mm diameter pole. Also available in other finishes.

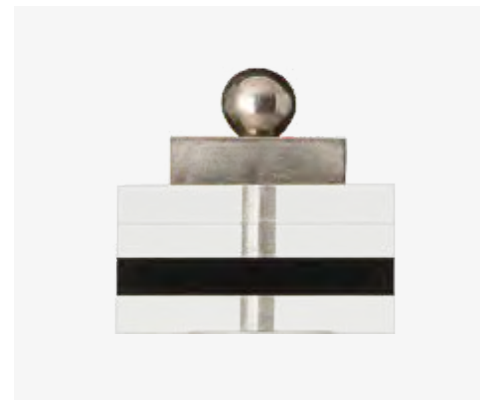

**F228 - Square Perspex and Metal**

Perspex and Metal Squares Curtain Pole Finial shown in Clear and Black Perspex Squares and Metal Square in Antiqued Silver finish with Marble in Polished Nickel finish. Fits a 51mm diameter pole. Also available in other finishes.

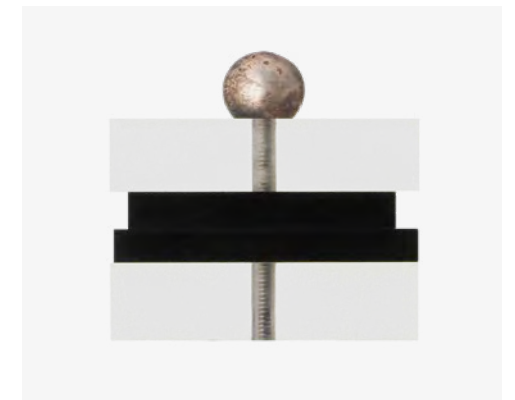

**F230 - Perspex Squares & Metal Marble**

Perspex Squares and Metal Marble Curtain Pole Finial shown in Clear and Black Perspex and Marble in Antiqued Silver finish. Fits a 51mm diameter pole. Also available in other finishes.





**F232 - Metal Squares**

Metal Squares Curtain Pole Finial shown in Antiqued Brass, Antiqued Copper and Antiqued silver finishes. Fits a 38mm diameter pole. Also available in other finishes. Available in other finishes.



**F233 - Metal Squares & Clear Perspex**

Metal Squares and Perspex Curtain Pole Finial shown in Clear Perspex and Antique Copper finish. Fits a 38mm diameter pole. Also available in other finishes.

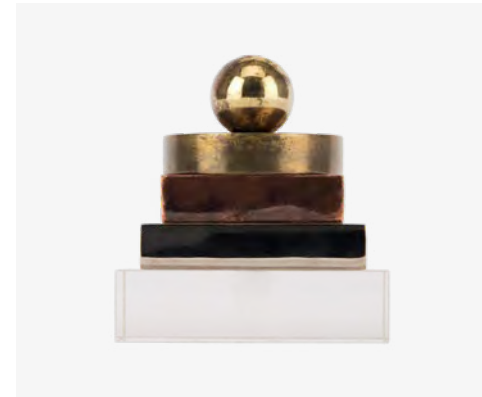

**F235 - SQ Clear Perspex & Metal Squares and Disc**

Square Metal & Perspex with Metal Disc Curtain Pole Finial shown in Clear Perspex, Antiqued Brass, Polished Nickel and Antique Copper finishes. Fits a 51mm diameter pole. Also available in other finishes.

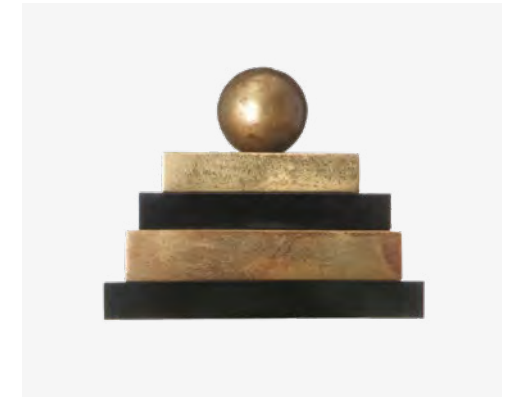

**F236 - Black Perspex & Square Metal**

Square Metal & Acrylic Curtain Pole Finial shown in Black Perspex and Antiqued Brass finish. Fits a 51mm diameter pole. Also available in other finishes.

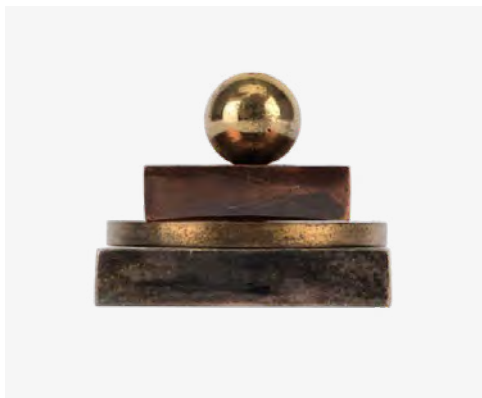

**F250 - Metal Squares & Metal Disc**

Metal Squares and Disc Curtain Pole Finial shown in Antiqued Brass, Antiqued Copper and Antiqued silver finishes. Fits a 51mm diameter pole. Also available in other finishes.

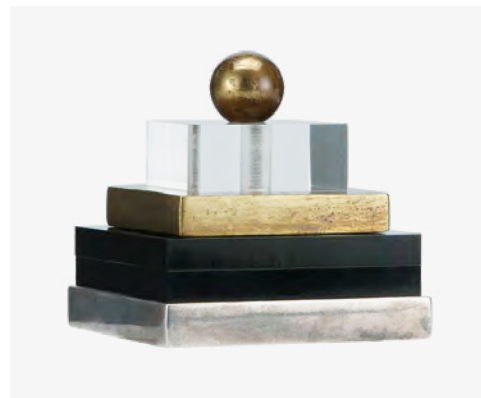

**F302 - Square Metal & Acrylic**

Square Metal & Acrylic Curtain Pole Finial shown in Clear Perspex, Antiqued Gilt, Black Perspex and Antiqued Silver finishes. Fits a 51mm diameter pole. Also available in other finishes.



**F307 - Square Lattice**

Square Lattice Wood Curtain Pole Finial shown in a Custom Gilt and Paint finish. Fits a 63mm diameter pole. Also available in other finishes.





Featured products:  
GF87 - Coloured Glass on Oblong on Metal Cup





**GF2 - Gold Kyoto Glass**

Gold Kyoto Glass Curtain Pole Finial. Fits a 38mm, 51mm and 63mm diameter pole.



**GF1 - Silver Kyoto Glass**

Silver Kyoto Glass Curtain Pole Finial. Fits a 38mm, 51mm and 63mm diameter pole.



**GF7 - Silver Glass Ball on Silver Glass Base**

Sliver Glass Ball on Silver Glass Base Finial. Fits a 38mm, 51mm and 63mm diameter pole.



**GF11 - Gold Glass**

Gold Glass Curtain Pole Finial. Fits a 38mm, 51mm and 63mm diameter pole.



**GF12 - Honey Ball Glass**

Honey Ball Solid Glass Curtain Pole Finial. Fits a 38mm, 51mm and 63mm diameter pole. Available in other finishes.







**GF14 - Clear Glass Ball on Clear Glass Base**

Clear Glass Ball on Clear Glass Base Curtain Pole Finial shown. Fits a 38mm, 51mm and 63mm diameter pole. They can be filled with different colour feathers, shells, corks and even smarties.



**GF14 - Clear Glass Ball on Clear Glass Base**

Finial shows Clear Glass ball with Frosted Band on Frosted Base finial. Fits a 38mm, 51mm and 63mm diameter pole. They can be filled with different colour feathers, shells, corks and even smarties.



**GF15 - Clear Solid Glass Ball with Metal Marble and Base**

Finial, shown in 51mm diameter size with Polished Nickel. Fits a 38mm and 51mm diameter poles. Also available in frosted glass and other metal finishes.



**GF16 - Clear Glass Ball on Metal Cup**

Clear Glass Ball on Antique Brass Cup Finial. Fits a 38mm, 51mm and 63mm diameter pole. Also available in frosted glass and other metal finishes.



**GF19 - Bubble Glass**

Bubble Solid Glass Curtain Pole Finial. Fits a 51mm diameter pole.



**GF22 - Clear Ball on Silver Base Glass**

Clear Glass Ball on Silver Glass Base Finial. Fits a 38mm, 51mm and 63mm diameter pole.



**GF23 - Coloured Glass Ball on Metal Cup**

Coloured Glass Ball on Metal Cup Finial, shown in Sage Coloured Ball on Copper Cup and Grey Coloured Ball on Antiqued Silver Cup. Fits a 38mm, 51mm and 63mm diameter pole. Also available in other glass and metal colours.



**GF23B - Bubble Solid Glass Ball on Metal Cup**

Bubble Solid Glass Ball on Antiqued Brass Cup finial. Fits a 38mm, 51mm and 63mm diameter pole. Also available in other glass and metal colours.





**GF27 - Coloured Crackle Glass**

Coloured Crackle Glass Finial. Fits a 38mm, 51mm and 63mm diameter pole. Also available in other colours and in clear glass.



**GF28 - Coloured Glass Ball on Coloured Glass Base**

Coloured Glass Ball on Coloured Glass Base Finial. Fits a 38mm, 51mm and 63mm diameter pole. Also available in other colours.



**GF31 - Black Glass Ball with Clear Glass Thread**

Clear Thread on Black Glass Curtain Pole Finial. Fits a 38mm, 51mm and 63mm diameter pole. Also available in silver ball with clear threads on silver or clear base.



**GF39 - Glass & Metal Stacks**

Glass Squares & Metal Discs Stacks Curtain Pole Finial shown in Antiqued Brass and Clear Glass. Fits a 51mm diameter pole. Also available in frosted glass and other metal finishes.



**GF40 - Frosted Glass Pebble on Metal Cup**

Frosted Glass Pebble on Polished Nickel Cup Finial. Fits a 38mm diameter pole. Also available in clear glass and other metal finishes.



**GF47 - Clear Glass Squares**

Clear Glass Squares Finial. Fits a 51mm diameter pole. Also available in frosted glass and other metal finishes.



**GF52 - Coloured Glass Ball on Clear Glass Base**

Coloured Glass Ball on Clear Glass Base Finial. Fits a 38mm, 51mm and 63mm diameter pole. Also available in other colours.



**GF54 - Opaque White Glass Ball with Black Top**

Opaque White Glass Ball with Black Top and Base Curtain Pole Finial. Fits a 38mm, 51mm and 63mm diameter pole.





Featured product:  
**GF68 - Ribbed Pumpkin Glass**



**GF55 - Denim Ball with Frosted Detail Glass**

Denim Ball with Frosted detail Glass Curtain Pole Finial. Fits a 38mm, 51mm and 63mm diameter pole.

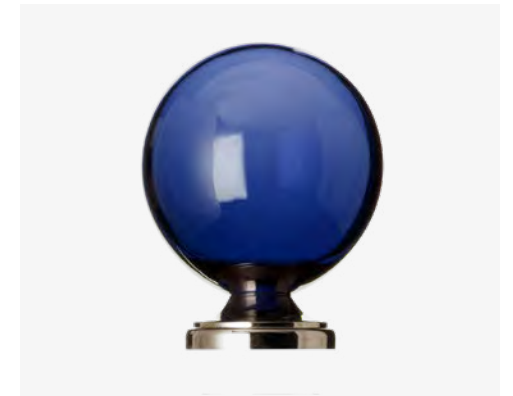

**GF66 - Coloured Ball on Metal Base**

Coloured Glass Ball on Polished Nickel Base Finial. Fits a 51mm diameter pole. Also available in other colours and metal finishes.



**GF68 - Ribbed Pumpkin Glass**

Ribbed Pumpkin Glass Curtain Pole Finial. Fits a 38mm, 51mm diameter pole. Available in other colours.



**GF78 - Multicoloured Splash**

Multicoloured Splash Glass Ball Finial Fits a 63mm diameter pole. Also available in other colours.



**GF71 - Spike Glass**

Clear Glass Spike Finial.  
Fits a 38mm and 51mm diameter pole.  
Also available in colour glass.



**GF80 - Blue Ball with White Spots and White Base**

Blue Glass Ball with White Spots on White Base Finial. Fits a 38mm, 51mm and 63mm diameter pole. Also available in other colours.



**GF86 - Coloured Glass Ball on Half Metal Cup**

Coloured Glass Ball on Half Metal Cup Curtain Pole Finial. Fits a 51mm diameter pole. Available in other colours and metal finishes.



**GF87 - Coloured Glass Oblong on Metal Cup**

Coloured Glass Oblong on Metal Cup Finial, shown in 38mm diameter size in Magenta Coloured Oblong and Satin Nickel. Fits a 38mm, 51mm and 63mm diameter poles. Also available in other glass and metal colours.



**GF88 - Coloured Glass Oblong on Clear Glass Base**

Coloured Glass Oblong on Clear Glass Base Finial, shown 51mm diameter size in Blue Glass. Fits a 38mm, 51mm and 63mm diameter pole. Also available in other colours.



**F69 - Filigree Palmette**

Filigree Palmette Curtain Pole Finial shown in Antiqued Brass finish. Fits a 38mm diameter pole. Also available in other finishes.



**F39 - Coronet**

Coronet Curtain Pole Finial shown in Polished Nickel finish. Fits a 38mm and 51mm diameter poles. Also available in other finishes.

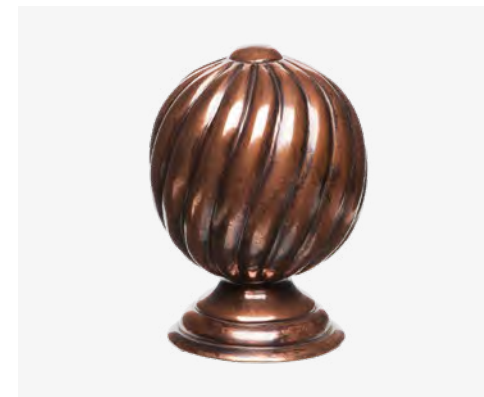

**F40 - Twisted Ball**

Finial shown in metal 38mm diameter in Aged Copper. Fits a 38mm, 51mm and 63mm diameter poles. It can be made in metal and wood in the 3 sizes, and in resin in 38mm and 51mm diameter sizes. Also available in different finishes.

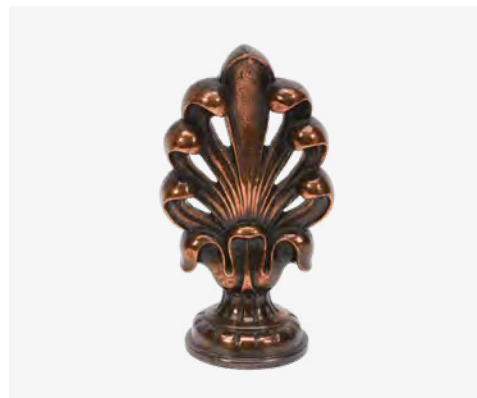

**F52 - Flat Acanthus**

Flat Acanthus Metal Curtain Pole Finial shown in Antiqued Copper. Fits a 51mm diameter pole. Also available in other finishes.



**F74 - Small Pineapple with Leaves**

Small Pineapple with Leaves Metal Pole Finial shown in 51mm diameter in Antique Brass finish. Fits with the leaves a 51mm diameter pole and without the leaves a 25mm pole. Also available in other finishes.



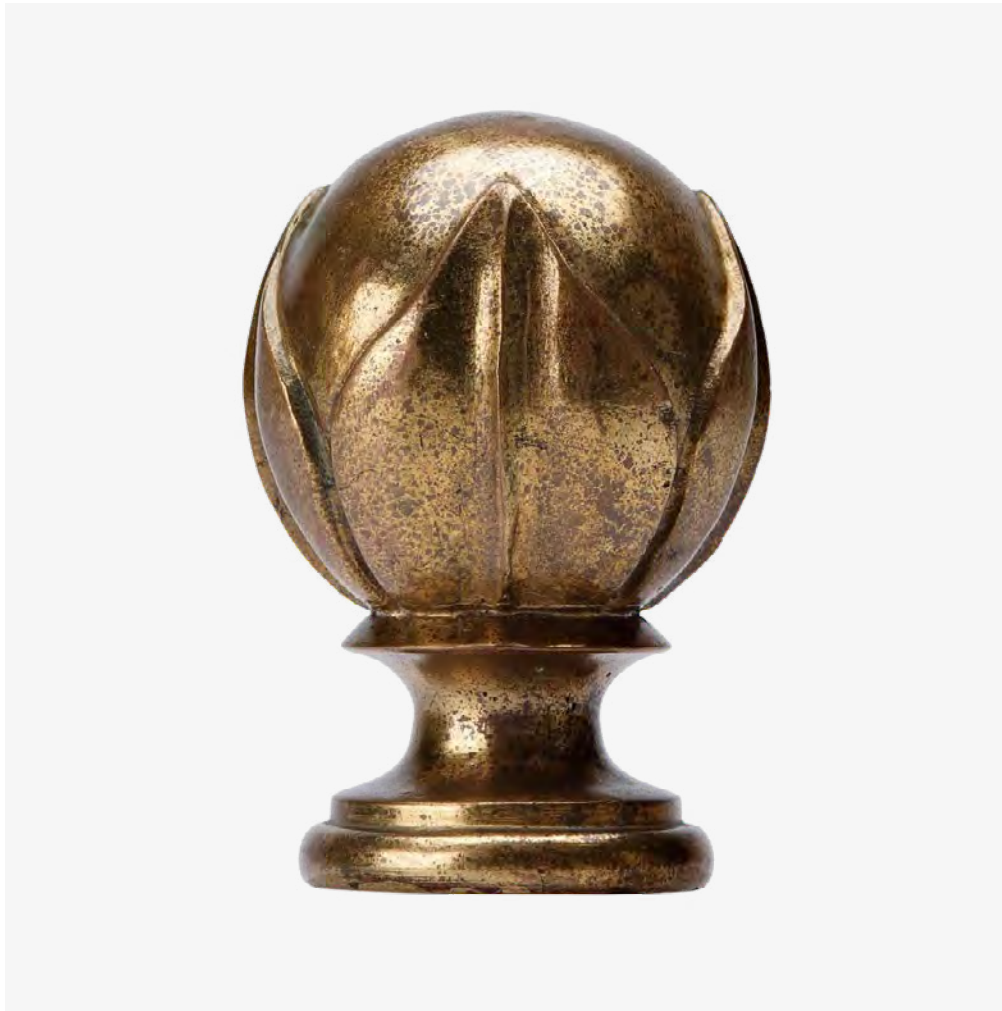

**F147 - Acanthus Cup**

Acanthus Cup Curtain Pole Finial shown in 38mm diameter in metal Antiqued Brass finish. Fits a 38mm, 51mm and 63mm diameter poles. It can be made in wood and resin in all 3 sizes and in metal in 38mm and 51mm diameters. Available in other finishes.



**F263 - Metal Ribbed Ball**

Metal Ribbed Ball Curtain Pole Finial shown in 51mm diameter size in Antique Gilt finish. Fits a 25mm, 38mm and 51mm diameter poles. It can also be made in resin and it is sold in a set in our McKinney Direct range. Also available in different finishes.



**F297 - Pineapple Metal**

Pineapple Metal Curtain Pole Finial shown in Antique Gilt finish and 2 available sizes. Fits a 51mm and 63mm diameter poles. Also available in other finishes.



**F166 - Wreath Button**

Wreath Button Metal Curtain Pole Finial shown in Antiqued Brass finish. Fits a 51mm diameter pole. It can also be made in wood. Also available in other finishes.



**F296 - Metal Flat Top**

Flat Top Metal Finial shown in Polished Nickel finish. Fits a 63mm diameter pole. Also available in wood and other finishes.





**Antiqued Brass Plain Flush End Disc**  
Suitable for corded and inverted corded poles.

**Polished Nickel Plain Flush End Disc**

**Antiqued Brass Plain End Disc**

**F240 - End Cap**

Fits 25mm, 38mm, 51mm, 63mm and 76mm diameter poles.  
Available in other finishes.



**F238 - Ribbed Wood**

Ribbed End Cap shown in a stained finish. Fits 38mm, 51mm and 63mm diameter poles. Available in other finishes.



**F239 - Dommed Wood**

Dommed Ribbed End Cap shown in a stained finish. Fits 38mm, 51mm and 63mm diameter poles. Available in other finishes.



**F241 - Plain Antiqued Brass**

Antiqued Brass Plain End Cap. Available to fit 25mm, 38mm, 51mm, 63mm and 76mm diameter poles. Available in other finishes.



**F241 - Polished Nickel**

Polished Nickel End Cap. Available to fit 25mm, 38mm, 51mm, 63mm and 76mm diameter poles. Available in other finishes.



# Curtain Poles

We offer a huge range of curtain pole options for every window size & budget. From the simplest narrow French return and corded wood curtain poles to large eclectic bay curtain poles we can confidently supply your exact requirement. We also have a template and fitting service and can happily visit you on site to advise you on your best options.

- |                   |   |                    |   |
|-------------------|---|--------------------|---|
| Plain Wood        | > | Fine Reeded Metal  | > |
| Reeded Wood       | > | Perspex            | > |
| Fine Reeded Wood  | > | Square Poles       | > |
| Fluted Wood       | > | Rectangular Poles  | > |
| Barley Twist Wood | > | Double Pole System | > |
| Plain Metal       | > | Half Poles         | > |
| Twisted Metal     | > | French Returns     | > |
| Reeded Metal      | > |                    |   |







## Plain Wood



Featured products:  
**Wood Pole 63mm, shown with F265 Finial**

Shown in Stain Light Oak finish.  
F265 Wood Moroccan Urn Finial.  
Also available in other finishes.  
Poles can be made to specific lengths and will be supplied in 2 pieces over 2.70m long, in 2 pieces over 2.70m long.



Wood Pole 38mm diameter



Wood Pole 51mm diameter



Wood Pole 63mm diameter



## Reeded Wood



Featured products:  
**Reeded Wood Pole 51mm, shown with F74 Finial**

Reeded Wood Curtain Pole 51mm in diameter, Stain #12.  
F74 Small Pineapple with Leaves finial in Antique Brass.  
Available in other finishes.  
Poles can be made to specific lengths and will be supplied in 2 pieces over 2.70m long.



Reeded Wood Pole 38mm diameter



Reeded Wood Pole 51mm diameter



## Fine Reeded Wood



Featured products:

### **Fine Reeded Wood Pole 38mm, shown with F40 Finial**

Fine Reeded Wood Curtain Pole 38mm in diameter.  
Imitation Gilt GG.  
Twisted Ball Finial in Resin and also Available in Wood.  
Available in other finishes.  
Poles can be made to specific lengths and will be supplied in 2 pieces over 2.70m long.



**Fine Reeded Wood Pole 38mm diameter**



**Fine Reeded Wood Pole 51mm diameter**



## Fluted Wood



Featured products:  
**Fluted Wood Pole 51mm, shown with F4 Finial**

Wood Curtain Pole 51mm in diameter.  
Stained and Limed Finish.  
F4 - Wood Pineapple Finial.  
Available in other finishes.  
Poles can be made to specific lengths and will be supplied in 2 pieces over 2.70m long.



Fluted Wood Pole 51mm diameter

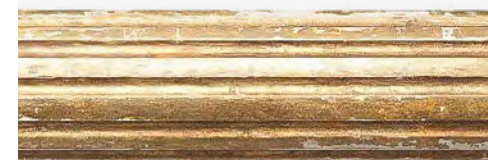

Fluted Wood Pole 63mm diameter



## Barley Twist Wood



Featured products:  
**Barley Twist Wood Pole 51mm, shown with F133 Finial**

Barley Twist Wood Curtain Pole 63mm in diameter.  
Shown in Layered Birch Finish.  
133 - Cut Away Ball Layered Birch Finial.  
Available in other finishes.  
Poles can only be made in one piece up to 1.5m, anything longer will need to be made in 2 pieces.



Barley Twist Wood Pole 51mm diameter



Barley Twist Wood Pole 63mm diameter



## Plain Metal



Featured products:  
**Polished Nickel Pole 63mm, shown with F190 Finial**

Metal Curtain Pole 63mm in diameter.  
Polished Nickel.  
Simple Solid Glass Ball and Metal Finial.  
Available in other finishes.  
Poles made to specific lengths and will be supplied in 2 pieces over 2.70m long.

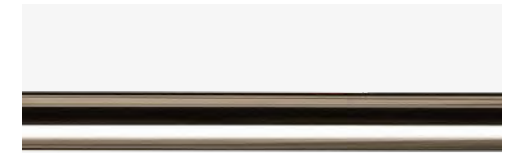

Plain Metal Pole 25mm diameter



Plain Metal Pole 38mm diameter

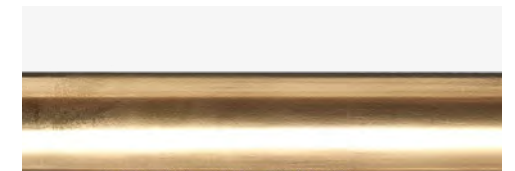

Plain Metal Pole 51mm diameter

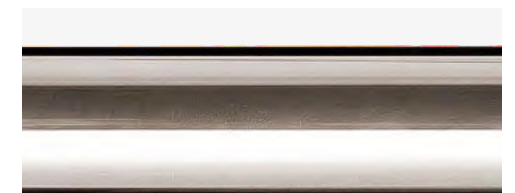

Plain Metal Pole 63mm diameter



## Twisted Metal

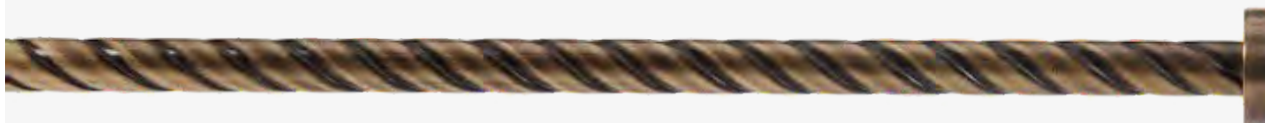

Featured product:  
**Twisted Antique Brass Pole 19mm**

Twisted Metal Curtain Pole 19mm in diameter.  
Antique Brass.  
Overlapping End Disc Metal Finial.  
Available in other finishes.  
Poles made to specific lengths and will be supplied in 2 pieces over 2.70m long.



Twisted Metal Pole 19mm diameter



Twisted Metal Pole 38mm diameter



## Reeded Metal



Featured products:  
**Reeded Antique Brass Pole 51mm, shown with F98 Finial**

Metal Reeded Curtain Pole 51mm in diameter.  
Antique Brass.  
Acanthus Metal Finial.  
Available in other finishes.  
Poles made to specific lengths and will be supplied in 2 pieces over 2.70m long.



Reeded Metal Pole 51mm diameter



Reeded Metal Pole 80mm diameter





## Fine Reeded Metal



Featured products:  
**Fine Reeded Antique Brass Pole 51mm, shown with F29 Finial**

Metal Curtain Pole 51mm in diameter.  
Antique Brass.  
Plain Ball End Finial in antique brass finish.  
Available in other finishes.  
Poles made to specific lengths and will be supplied in 2 pieces over 2.70m long.



# Perspex



Featured products:  
**Hollow Perspex Pole filled with Shells 50mm, shown with F229 Finial**

Solid Square Perspex Pole 50mm square.  
Clear Perspex.  
Clear Perspex and Antiqued Brass squares with clear glass marble Finial.  
Available in black Perspex.  
Poles can be made to specific lengths and will be supplied in 2 pieces over 2m long.

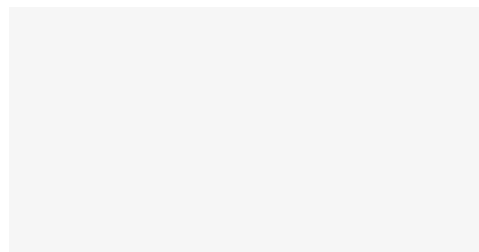

Perspex Square Pole 40mm diameter

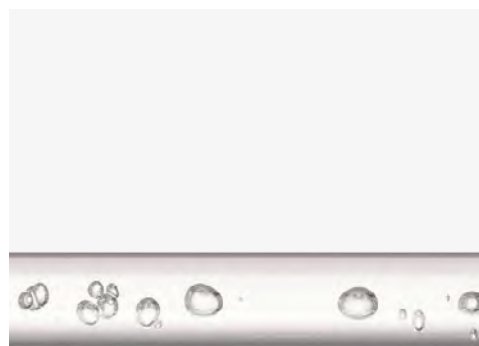

Perspex Round Pole 50mm diameter



# Square



Featured products:  
**Square Copper Pole 40mm, shown with F233 Finial**

Metal Curtain Pole 40mm square.  
Copper.  
Perspex and Metal squares with metal marble Finial.  
Available in other finishes.



**Square Pole** 40mm diameter



**Square Pole** 50mm diameter



**Square Pole** 51mm diameter



## Rectangular



Featured products:  
**Copper Rectangular Pole, shown with F300 Finial**

The simple clean lines of our rectangular poles are a new addition to our range and are available in any of our metal finishes and in Perspex. The metal rectangular rings are lined with nylon to facilitate a smooth draw and as with our square poles the finials can be stacked allowing our clients to create their own design. Shown here in Copper finish with F300 finial.



Perspex Rectangular Pole with F300B



## Double Pole System



Featured product:  
**Metal Double Pole System**

The options for the double pole system are endless, motorised large poles in front and narrow hand drawn poles behind. Mixed materials, same diameter, the choice is amazing. The double cup brackets are all bespoke so that the curtains hang beautifully. Double poles are also available for bay windows.

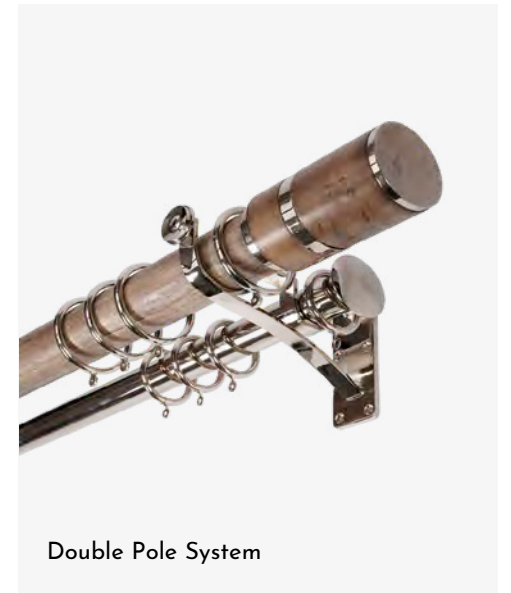

Double Pole System



## Half Poles



Featured product:  
**Reeded Wood Half Pole 63mm**

Reeded Wood 63mm Half Pole in Stain #40 finish, with roof and returns back onto the wall.  
Supplied with Kirsch corded track for single or double curtains.  
It can be made with one or 2 returns.  
Our Half Poles are made to order to specific lengths and they can often be adapted to fit irregular architectural details and can also be made to fit bay windows.



Half Pole 51mm diameter



Half Pole 63mm diameter



## French Returns



Featured product:  
**Burnished Steel French Return 20mm**

The French return style is a perfect option for a classic simple curtain treatment and is an excellent way of getting the fabric off the window and dealing with greater bracket extension requirements. The French return poles shown are solid 20mm in diameter and are also available in 25mm. All lengths and returns are custom and the back plates can be adapted to fit different spaces. Likewise these French returns are wonderful as double poles where the secondary pole can be fitted onto the returns to hold sheer curtains. We also supply solid Perspex French return poles in 40mm and 50mm diameter. Hollow French returns in all metal finishes from bronze to copper to nickel are available in 25mm, 38mm and 51mm diameters. These French returns are fitted to the wall with standard recess brackets.



**French Return 20mm diameter**



**French Return 25mm diameter**



# Pelmets & Coronas

Our Pelmet (also known as Cornice Boards) & Corona range can be fully customised to create any desired look and feel. Pelmet length and returns are bespoke to your specifications, and we can adapt the depth where necessary.







**PC1 - Arched Pelmet**

Wood MDF and Compo pelmet board shown in gold imitation gilt finish. Available in other finishes.

Our pelmet boards are made to order to specific lengths, they can often be adapted to fit irregular architectural details and can also be made to fit bay windows. Fittings and curtain tracks are not included in the price of the pelmets and coronas but can be provided upon request.

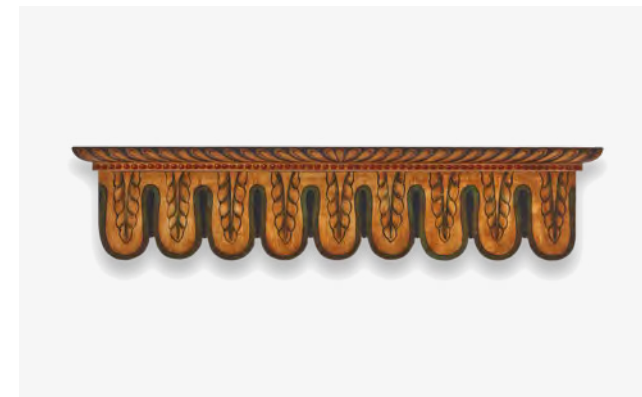

**PC2 - Finger Pelmet**

Wood and MDF pelmet board shown in a painted finish. Available in other finishes.



**PC4 - Scroll Pelmet**

Wood and MDF pelmet board shown in a painted finish with imitation gilt detail. Available in other finishes.

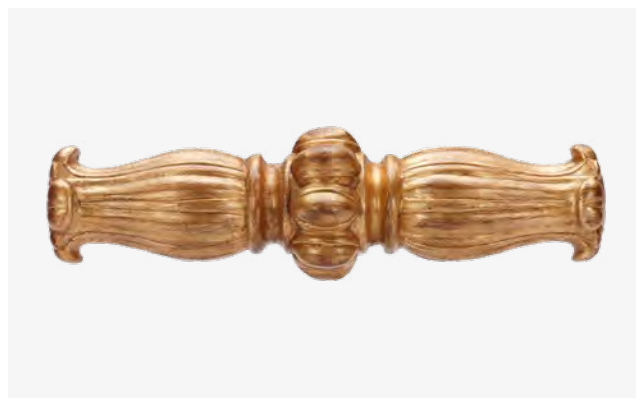

**PC6 - Resin Centre Piece**

Resin centre piece shown in gold imitation gilt finish. Available in other finishes. Our centre pieces can be used on simple pelmet boards and on curtain poles.



**PC7 - French Pelmet**

Wood and MDF pelmet board shown in two contrasting painted finishes. Available in other finishes.





**PC8 - Crown Corona**

Wood corona shown with marbles and in AL2 Gold Imitation Gilt finish. Available in other finishes.



**PC8 - Crown Corona**

Wood corona shown in AL Gold Imitation Gilt finish. Available in other finishes.



**PC9 - Wood & Compo Corona**

Wood and Compo corona shown in a painted finish with imitation gilt detail. Also available as a pelmet board and in other finishes.



**PC11 - Acanthus Corona**

Wood and Compo corona shown in a painted faux bois finish with imitation gilt detail. Also available as a pelmet board and in other finishes.



**PC13 - Floral Corona**

Wood and Compo corona shown in a painted finish with imitation gilt detail. Available in other finishes.



**PC14 - Corona**

Wood and Compo corona shown in a gold watergilt finish. Also available as a pelmet board and in other finishes.





**PC23 - Narrow Moulded Pelmet**

Wood pelmet board with resin centre piece shown in gold imitation gilt finish. Available in other finishes.



**PC26 - Trailing Leaf Pelmet**

Wood and Compo pelmet board shown in a silver imitation gilt finish. Available in other finishes.



**PC29 - Acanthus Fingers Pelmet**

Wood and Compo pelmet board shown in a painted finish with imitation gilt detail. Available in other finishes.



**PC30 - Simple Rounded Wood Pelmet**

Wood pelmet board shown in a stain wood finish. Available in other finishes



**PC33 - Square Lattice Pelmet**

Square Lattice pelmet board shown on main image in a painted finish with imitation gilt detail. Available in other finishes.



**F93 - Resin Centre Piece**

Resin centre piece shown in gold imitation gilt finish. Available in other finishes. Our centre pieces can be used on simple pelmet boards and on curtain poles.





## Tie Backs

The McKinney & Co curtain tieback range incorporates all the styles in our finial range, and again most come in a variety of materials. As standard the tieback stems are supplied with a 6"/15cm stem length, but this, the tieback size & back plate can be customised.

Glass & Perspex



Metal



Wood & Resin





- Featured products (from top left):
- T8 - Simply Round
  - T28 - Metal Filigree
  - GT19 - Gold Kyoto Glass
  - T3 - Gilt Greek Key
  - T6 - Resin Rococo
  - T17 - Georgian Rose
  - GT27 - Flower Glass
  - T13 - Metal Lion Head
  - T43 - Metal & Leather
  - T63 - Wood & Metal Ribbed
  - GT25 - Silver Kyoto Glass
  - T27 - Classic Oval
  - T22 - Resin Gesso Flower
  - T33 - Resin Stylised Flower
  - T23 - Metal Shrunken Georgian
  - T34 - Metal & Wood Classic Modern
  - GT28 - Alabaster Centre
  - T81 - 3 Parts Square
  - T50 - Silver Gilt
  - T57 - Twisted Resin





**GT19 - Gold Kyoto Glass**

Gold Kyoto Glass Curtain Tieback.  
Standard stem length 15cm, other sizes available on request.  
Small and large back plates are supplied to suit the tieback diameter.



**GT20 - Gold Centre Kyoto**

Clear Disc with Gold Kyoto Centre Curtain Tieback.  
Also available with Frosted Disc. Standard stem length 15cm, other sizes available on request. Small and large back plates are supplied to suit the tieback diameter.



**GT22 - Blue Swirl Glass**

Blue Swirl Glass Tieback. Standard stem length 15cm, other sizes available on request. Small and large back plates are supplied to suit the tieback diameter.



**GT24 - Clear Ball Glass**

Clear Glass Ball Curtain Tieback. Also available in frosted glass. Standard stem length 15cm, other sizes available on request. Small and large back plates are supplied to suit the tieback diameter.



**GT25 - Silver Kyoto Glass**

Silver Kyoto Glass Curtain Tieback. Standard stem length 15cm, other sizes available on request. Small and large back plates are supplied to suit the tieback diameter.



**GT27 - Flower Glass**

Six Layers Glass Flower Coloured Tieback. Standard stem length 15cm, other sizes available on request. Small and large back plates are supplied to suit the tieback diameter.

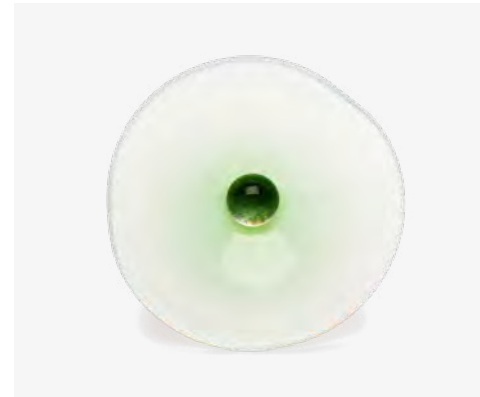

**GT27 - Single Flower Glass**

Single Flower with Glass Marble Tieback. Standard stem length 15cm, other sizes available on request. Small and large back plates are supplied to suit the tieback diameter.



**GT28 - Alabaster Centre**

Clear Glass with Alabaster Centre Curtain Tieback. Standard stem length 15cm, other sizes available on request. Small and large back plates are supplied to suit the tieback diameter.

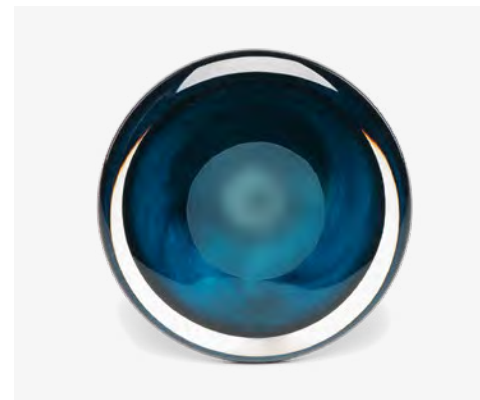

**GT29 - Denim Disc with Frosted Centre**

Denim Coloured Glass with Frosted Centre Curtain Tieback. Standard stem length 15cm, other sizes available on request. Small and large back plates are supplied to suit the tieback diameter.



**GT30 - Opaque White & Black Centre Glass**

Opaque White with Black Centre Curtain Tieback. Standard stem length 15cm, other sizes available on request. Small and large back plates are supplied to suit the tieback diameter.





**GT31 - Square Glass**

Clear Square Tieback with Metal Marble. Also available in frosted glass. Metal parts are available in other metal finishes. Standard stem length 15cm, other sizes available on request. Small and large back plates are supplied to suit the tieback diameter.



**GT32 - Suede Tassel on Glass Ball**

Suede Tassel on Clear Solid Glass Ball Curtain Tieback. Also available in frosted glass. Standard stem length 15cm, other sizes available on request. Small and large back plates are supplied to suit the tieback diameter.



**T45 - Ribbed Perspex**

Clear Perspex Curtain Tieback. Available in Black perspex. Metal parts are available in other metal finishes. Standard stem length 15cm, other sizes available on request. Small and large back plates are supplied to suit the tieback diameter.



**T46 - Square Perspex**

Clear Perspex Curtain Tieback. Available in Black Perspex. Metal parts are available in other metal finishes. Standard stem length 15cm, other sizes available on request. Small and large back plates are supplied to suit the tieback diameter.







**T21 - Metal Shepard's Hook**

Shepard's Hook Tieback shown in Antiqued brass and Polished Nickel.  
Available in other finishes.

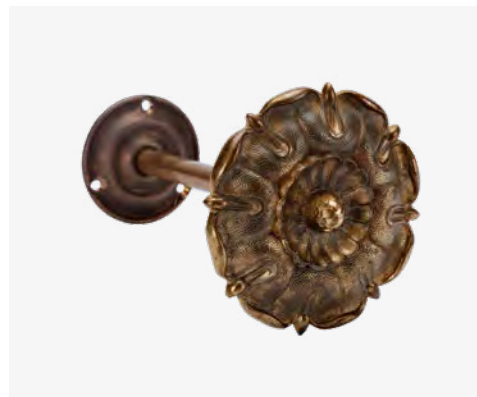

**T1 - Metal Tudor Rose**

Antiqued Brass Curtain Tieback. Available in other finishes. Standard stem length 15cm, other sizes available on request. Small and large back plates are supplied to suit the tieback diameter.

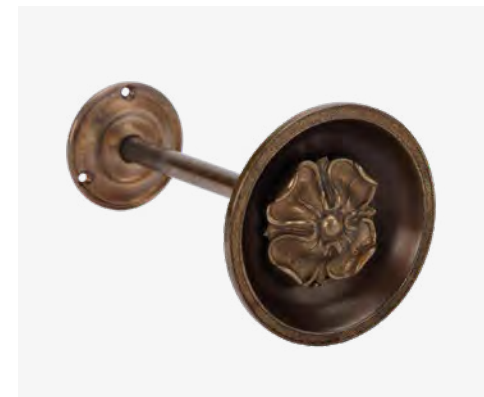

**T2 - Metal Shrunken Flower**

Antiqued Brass 2 tone Curtain Tieback. Available in other finishes. Standard stem length 15cm, other sizes available on request. Small and large back plates are supplied to suit the tieback diameter.



**T76 - Swan Neck Tie Back**

Swan Neck Tieback shown in Dark Bronze.  
Available in other finishes.



**T4 - Metal Victorian Rose**

Antiqued Brass Curtain Tieback. Available in other finishes. Standard stem length 15cm, other sizes available on request. Small and large back plates are supplied to suit the tieback diameter.



**T8 - Simply Round**

Polished Nickel Curtain Tieback. Available in other finishes including wood. Standard stem length 15cm, other sizes available on request. Small and large back plates are supplied to suit the tieback diameter.





**T8 - Simply Round with Tassel Hook**

Antique Gilt Curtain Tieback with hook to hold curtain tassels. Available in other finishes including wood. Standard stem length 15cm, other sizes available on request. Small and large back plates are supplied to suit the tieback diameter.



**T10 - Metal Rosette**

Antiqued Brass Curtain Tieback. Available in other finishes. Standard stem length 15cm, other sizes available on request. Small and large back plates are supplied to suit the tieback diameter.



**T11 - Rosette**

Polished and Satin Nickel Curtain Tieback. Available in other finishes. Standard stem length 15cm, other sizes available on request. Small and large back plates are supplied to suit the tieback diameter.



**T12 - Metal Rosette**

Antiqued Brass Curtain Tieback. Available in other finishes. Standard stem length 15cm, other sizes available on request. Small and large back plates are supplied to suit the tieback diameter.



**T13 - Metal Lion Head**

Polished Nickel and Black Curtain Tieback. Available in other finishes. Standard stem length 15cm, other sizes available on request. Small and large back plates are supplied to suit the tieback diameter.

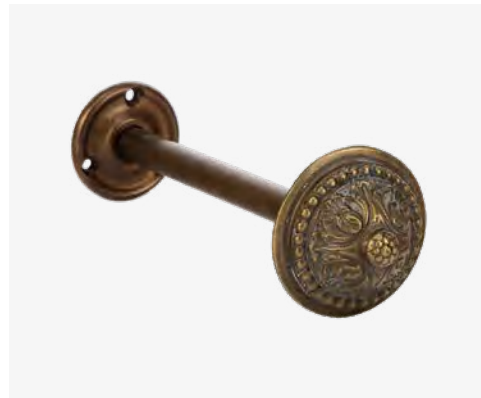

**T14 - Metal Small Classical**

Antiqued Brass Curtain Tieback. Available in other finishes. Standard stem length 15cm, other sizes available on request. Small and large back plates are supplied to suit the tieback diameter.

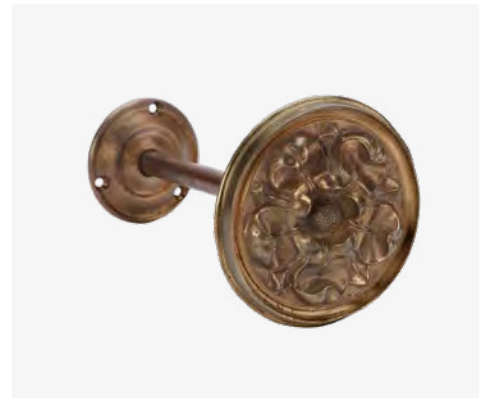

**T17 - Georgian Rose**

Antiqued Brass Curtain Tieback. Available in other finishes. Standard stem length 15cm, other sizes available on request. Small and large back plates are supplied to suit the tieback diameter.



**T19 - Metal Star**

Antiqued Brass Curtain Tieback. Available in other finishes. Standard stem length 15cm, other sizes available on request. Small and large back plates are supplied to suit the tieback diameter.





**T23 - Metal Shrunken Georgian**

Antiqued Brass Curtain Tieback. Available in other finishes. Standard stem length 15cm, other sizes available on request. Small and large back plates are supplied to suit the tieback diameter. Available in other finishes.



**T24 - Double Palmelle**

Polished Nickel Double Arm Curtain Tieback. Available in other finishes. The T24 also comes as a single arm curtain tieback.



**T24 - Single Palmelle**

Polished Nickel Single Arm Curtain Tieback. Available in other finishes. The T24 also comes as a double arm curtain tieback.

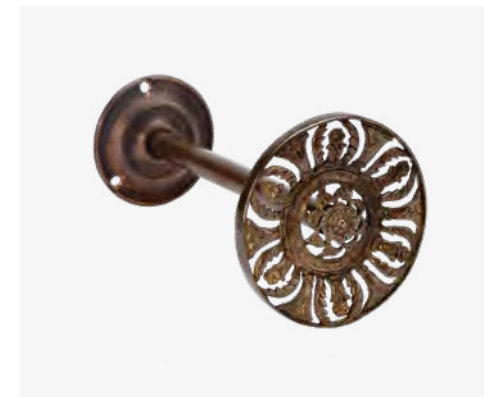

**T28 - Metal Filigree**

Antiqued Brass Curtain Tieback. Available in other finishes. Standard stem length 15cm, other sizes available on request. Small and large back plates are supplied to suit the tieback diameter.

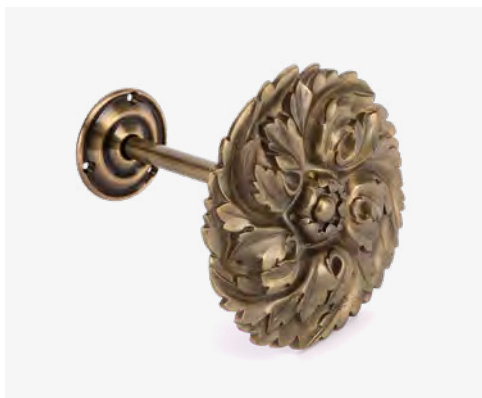

**T30 - Metal Edwardian Rose**

Antiqued Brass Curtain Tieback. Available in other finishes. Standard stem length 15cm, other sizes available on request. Small and large back plates are supplied to suit the tieback diameter.



**T31 - Metal & Wood Domed**

Leather and Polished Nickel Curtain Tieback. Available in other finishes. Standard stem length 15cm, other sizes available on request. Small and large back plates are supplied to suit the tieback diameter.



**T34 - Metal & Wood Classic Modern**

Antiqued Brass and Stained Wood Curtain Tieback. Available in other finishes. Standard stem length 15cm, other sizes available on request. Small and large back plates are supplied to suit the tieback diameter.

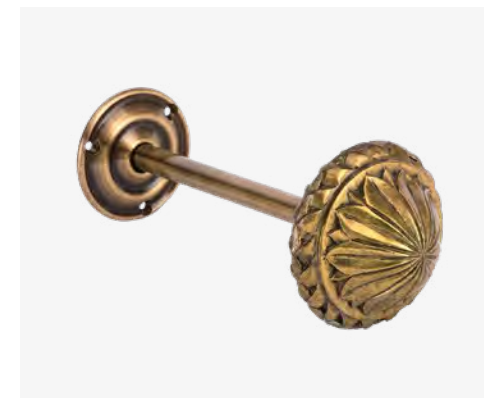

**T42 - Wreath Button**

Antiqued Brass Curtain Tieback. Available in other finishes. Standard stem length 15cm, other sizes available on request. Small and large back plates are supplied to suit the tieback diameter. Available in other finishes.





**T52 - Metal / Perspex Modern**

Polished Nickel and Clear/Perspex Curtain Tieback. Available in other finishes. Standard stem length 15cm, other sizes available on request. Small and large back plates are supplied to suit the tieback diameter.



**T65 - Metal Crest Arm**

Antiqued Brass Fixed Arm Curtain Tieback. Available in other finishes.

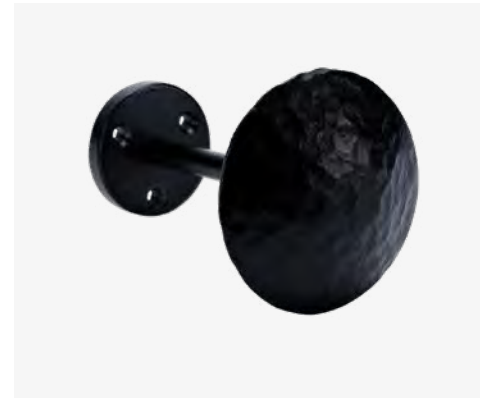

**T72 - Hammered Black Iron**

Hammered Black Iron Curtain Tieback. Also available in Stainless Steel and Burnished Steel. Standard stem length 10cm, other sizes available on request.

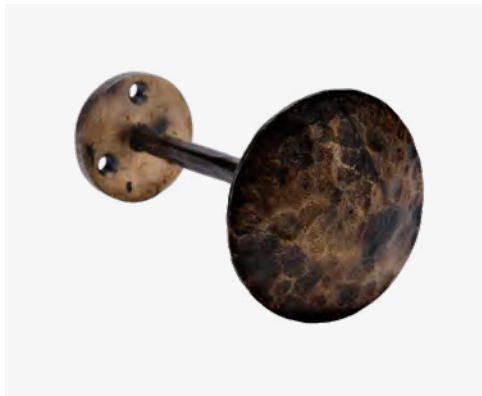

**T72 - Hammered Brass**

Hammered Brass Finish Curtain Tieback. Also available in Stainless Steel and Burnished Steel. Standard stem length 10cm, other sizes available on request.



**T79 - Metal Disc**

Dark Antiqued Brass Curtain Tieback. Available in other finishes. Standard stem length 15cm, other sizes available on request. Small and large back plates are supplied to suit the tieback diameter.



**T80 - Swing Leaf**

Swing Leaf Tieback shown in Antiqued brass. Available in other finishes.

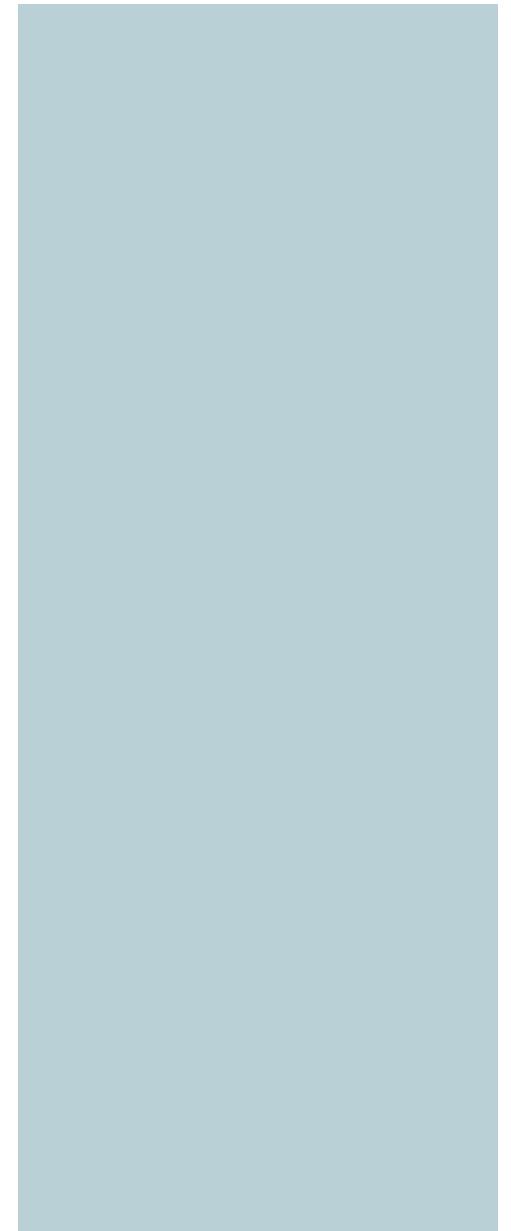



**T6 - Resin Rococo**

Resin Tieback in GG Imitation Gilt Finish. Available in other finishes. Standard stem length 15cm, other sizes available on request. Small and large back plates are supplied to suit the tieback diameter.



**T5 - Plain Wood**

Stained Wood Curtain Tieback. Available in other finishes. Standard stem length 15cm, other sizes available on request. Small and large back plates are supplied to suit the tieback diameter.

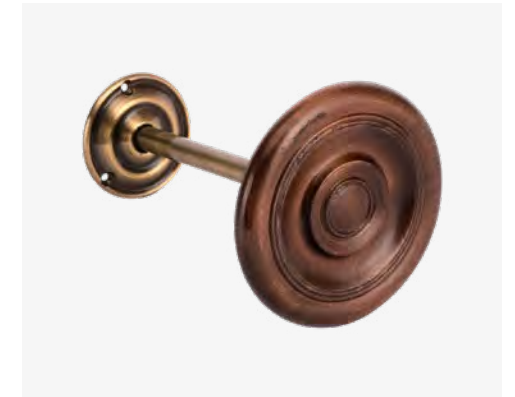

**T8 - Simply Round Wood**

Stained Wood Curtain Tieback. Available in other finishes. Standard stem length 15cm, other sizes available on request. Small and large back plates are supplied to suit the tieback diameter.



**T15 - Resin Leaf**

Resin Tieback in Gold Imitation Gilt Finish. Available in other finishes.



**T22 - Resin Gesso Flower**

Resin Tieback in Imitation Gilt and Dirty Varnish Finish. Available in other finishes. Standard stem length 15cm, other sizes available on request. Small and large back plates are supplied to suit the tieback diameter.





**T26 - Ribbed Wood Batton**

Stained Wood Curtain Tieback. Available in other finishes. Standard stem length 15cm, other sizes available on request. Small and large back plates are supplied to suit the tieback diameter. Available in other finishes.



**T33 - Resin Stylised Flower**

Resin tieback in AL2 Imitation Gilt Finish. Available in other finishes. Standard stem length 15cm, other sizes available on request. Small and large back plates are supplied to suit the tieback diameter.



**T34 - Metal & Wood Classic Modern**

Antiqued Brass and Stained Wood Curtain Tieback. Available in other finishes. Standard stem length 15cm, other sizes available on request. Small and large back plates are supplied to suit the tieback diameter.



**T49 - Wood Reflective Disc**

Wood Reflective Curtain Tieback. Standard stem length 15cm, other sizes available on request. Small and large back plates are supplied to suit the tieback diameter.



**T50 - Wood Weave**

Resin Tieback in SJ Imitation Gilt Finish. Available in wood and other finishes. Standard stem length 15cm, other sizes available on request. Small and large back plates are supplied to suit the tieback diameter.



**T53 - Wood & Perspex**

Stained Wood and Clear Perspex Curtain Tieback. Available in other finishes. Standard stem length 15cm, other sizes available on request. Small and large back plates are supplied to suit the tieback diameter.



**T57 - Twisted Resin**

Resin Tieback in Gold Imitation Gilt Finish. Also shown in Faux Bois finish. Available in other finishes. Standard stem length 15cm, other sizes available on request. Small and large back plates are supplied to suit the tieback diameter.

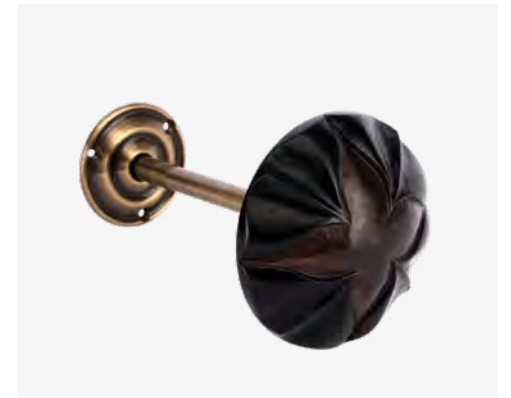

**T50 - Cut Out Wood**

Stained Wood Curtain Tieback. Available in other finishes. Standard stem length 15cm, other sizes available on request. Small and large back plates are supplied to suit the tieback diameter. Available in other finishes.





**T59 - Domed Acanthus**

Wood Tieback Stained with Gold Gilt Finish. Available in other finishes. Standard stem length 15cm, other sizes available on request. Small and large back plates are supplied to suit the tieback diameter.



**T60 - Wood Domed Acorn**

Stained Wood Curtain Tieback. Available in other finishes. Standard stem length 15cm, other sizes available on request. Small and large back plates are supplied to suit the tieback diameter.



**T63 - Wood & Metal Ribbed**

Wood Stained and Polished Nickel Curtain Tieback. Available in other finishes. Standard stem length 15cm, other sizes available on request. Small and large back plates are supplied to suit the tieback diameter.



**T66 - Resin Acorn Leaves**

Resin Tieback in Gold Imitation Gilt Finish. Available in other finishes.



**T67 - Resin Flower**

Resin Tieback in Imitation Gilt Finish. Available in other finishes. Standard stem length 15cm, other sizes available on request. Small and large back plates are supplied to suit the tieback diameter.

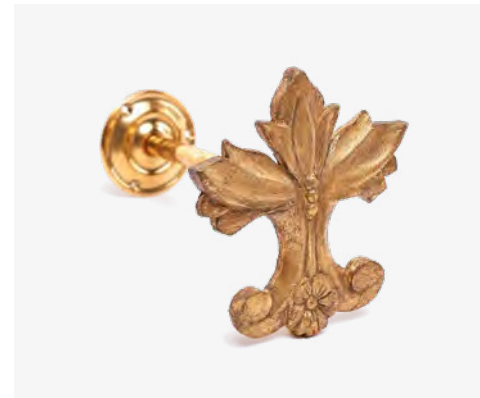

**F71 - Flat Decorative Resin**

Resin Tieback in YG Gold Imitation Gilt Finish. Available in other finishes. Standard stem length 15cm, other sizes available on request. Small and large back plates are supplied to suit the tieback diameter.

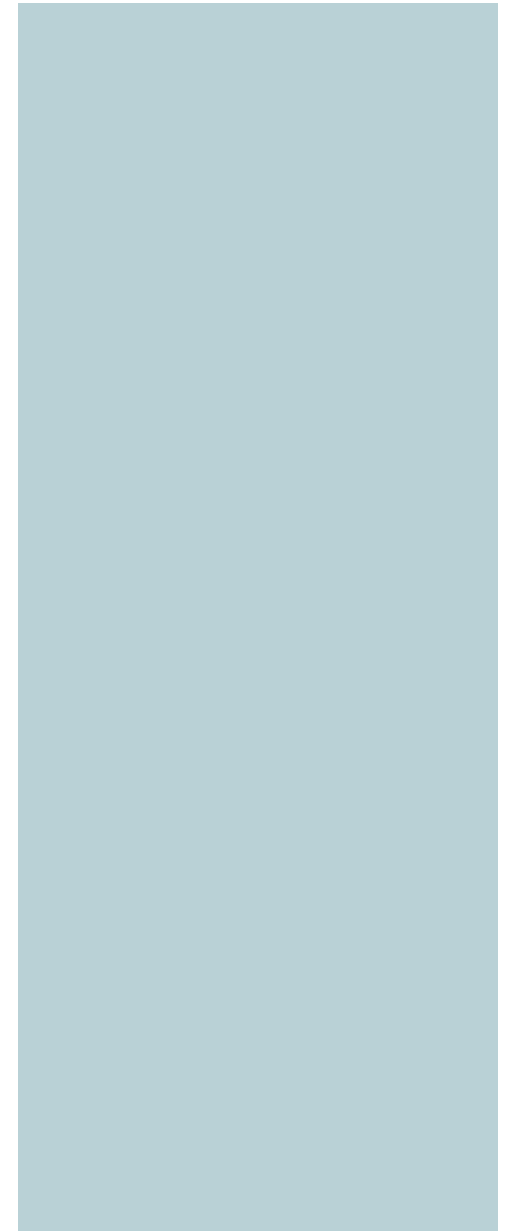



# Accessories

The McKinney & Co accessories range includes café rods, arms, draws and curtain rings. Our curtain rings are available in a wide choice of styles, with traditional round curtain rings, contemporary square & ribbed curtain rings & C passing curtain rings in a variety of finishes.





**Drapery Arm**

A traditional simple drapery arm for dormer windows and doors shown in main image in Polished Brass. The drapery arm consists of a wall mounted bracket, with a pivoting arm which carries the drapery rod and extends up to a maximum of 1m (39 3/8 ) across the opening. The arm can be swung aside as required. Available in other finishes.



**Drapery Arm**

A traditional simple drapery arm for dormer windows and doors shown in main image in Black Iron. The drapery arm consists of a wall mounted bracket, with a pivoting arm which carries the drapery rod and extends up to a maximum of 1m (39 3/8 ) across the opening. The arm can be swung aside as required. Available in other finishes.



**Polished Nickel Draw Rod**

Decorative Metal Draw Rod shown in Polished Nickel finish. Our metal draw rods are sold separately and they come in lengths of 75cm, 100cm and 125cm. Custom made sizes available on request. Also available in other finishes.



**White Powder Coated Draw Rod**

Decorative Metal Draw Rod shown in Powder Coated White finish. Our metal draw rods are sold separately and they come in lengths of 75cm, 100cm and 125cm. Custom made sizes available on request. Also available in other finishes.



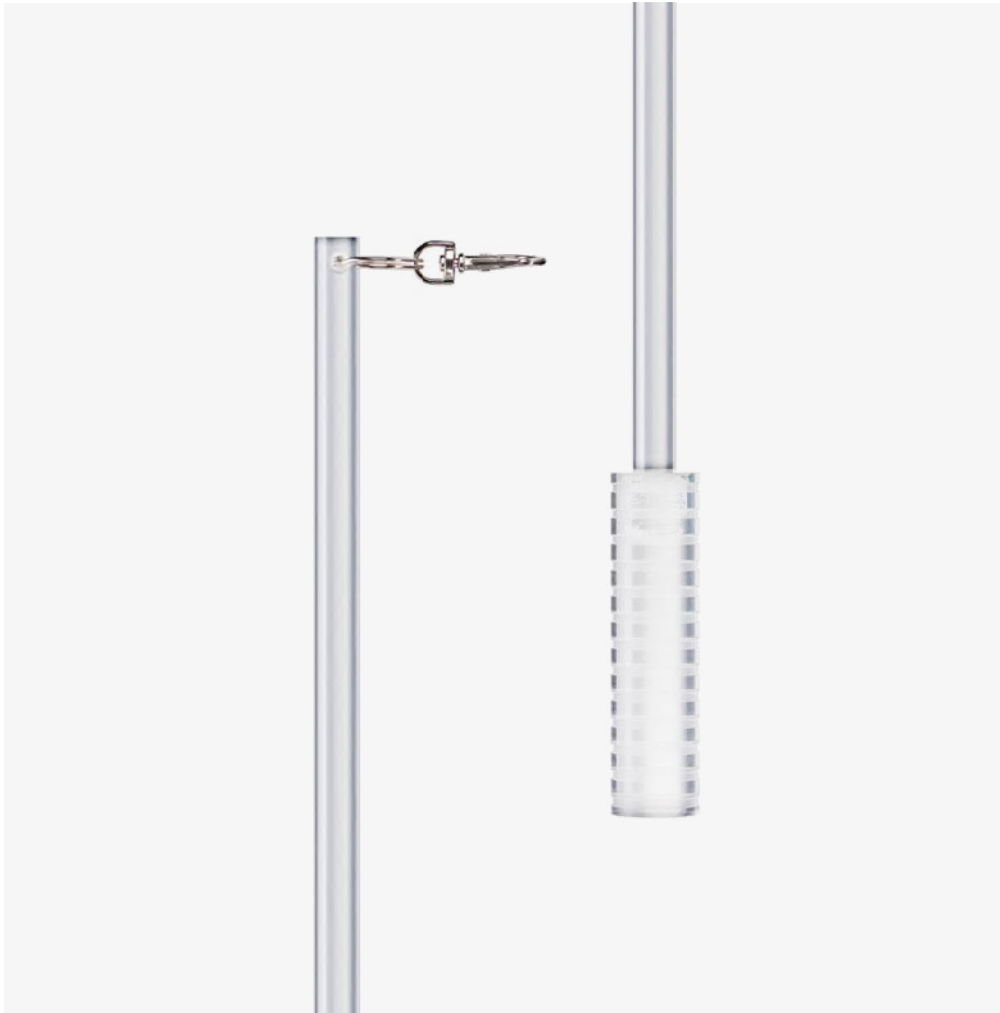

### Perspex Draw Rod

Modern Perspex Draw Rod. Our Perspex draw rods are sold separately and they come in lengths of 60cm and 121cm.



### Wood Draw Rod

Decorative Wooden Draw Rod shown in a Dark Mahogany stain colour. Our wooden draw rods are sold separately and they come in lengths of 75cm, 100cm and 125cm. Other finishes available on request.



**C Passing Metal Ring**

C passing plain metal ring shown in polished brass finish. Available to fit 25mm, 38mm, 51mm, 63mm and 76mm diameter poles. C passing centre brackets can also be supplied. Other finishes available. Available in other finishes.



**Clear Perspex Ring**

Perspex ring shown in clear finish. Available to fit 40mm, 50mm and 60mm diameter perspex poles. Square Perspex rings can be made in the same sizes as metal square rings. Can also be made in frosted and black perspex.



**Curtain Eyelets**

Metal Curtain Eyelets shown in Antiqued Bronze. Available to fit 38mm, 51mm and 63mm diameter metal poles. Other finishes available.



**Hollow Metal Ring**

Metal hollow rings shown in Antiqued Brass. Available to fit 25mm, 32mm, 38mm, 51mm, 63mm and 76mm metal poles. Other finishes available.



**Plain Wood Ring**

Plain wood ring shown in a stain finish. Available to fit 38mm, 51mm, 63mm and 76mm diameter poles. Other finishes available.



**Solid Metal Ring**

Metal solid rings shown in Antiqued Copper, Copper and Satin Copper. Available to fit 25mm, 38mm, 51mm, 63mm and 76mm metal poles. Other finishes available.



**Square Metal Ring**

Square solid metal ring shown in Antiqued Brass finish. Available to fit 40mm, 50mm and 60mm square metal poles. Other finishes available.



**Wood Grooved Ring**

Wood grooved ring shown in a stain finish with gold gilt detail in the groove. Available to fit 38mm, 51mm, 63mm and 76mm diameter poles. Other finishes available.





# Brackets & Facings

We supply standard curtain pole brackets in every metal finish, as well as wooden and perspex brackets. We are known for specialising in curtain pole brackets for the most challenging of pole fixings. All our metal brackets come with standard simple facings, and we also have more decorative bracket fronts to make them look more interesting. These are available in resin, wood, glass, and metal.





**B5 - Antiqued Brass Architrave Bracket**

This face fixed metal bracket comes with a strong vertical back plate to support the pole at different heights and it has a standard round facing to keep the pole in place. It fits poles from 25mm up to 76mm in diameter. They can be used with more decorative facings from our range. Other finishes are available.



**B6 - Antiqued Brass Centre Bracket**

This metal centre bracket has a more discreet back plate and comes with a standard round facing to keep the pole in place. Please note that only the 63mm diameter brackets have 4 screw holes on the back plates. It fits poles from 25mm up to 76mm in diameter. They can be used with more decorative facings from our range. Other finishes are available.



**B9 - Recess Bracket**

Recess bracket or socket brackets are ideal to use where space is restricted on one or both ends. They come with a fixed back plate or a removable one for fixing into a recess window. It fits poles from 25mm up to 76mm in diameter. They are also available in wood. Other finishes are available.



**B10 - Rope Bracket**

Rope Metal Bracket shown in Dark Bronze. This ceiling fixed metal bracket is the perfect alternative to face fixed brackets, where space is restricted or the pole needs to be fitted as close as possible to the ceiling and the length of the stem can be made to specific sizes. It fits poles from 25mm up to 76mm in diameter. Other metal finishes are available.



**B11 - Extendable 10-15cm Brackets**

These face fixed and centre metal brackets with an extendable projection between 10 to 15cm to the back of the cup and shown in Polished Nickel finish, come with a strong vertical back plate for the face fixed bracket and a horizontal back plate for the centre bracket to support the pole at different heights and it has a standard round facing to keep the pole in place. It fits poles from 38mm up to 63mm in diameter. They can be used with more decorative facings from our range. Also available in other finishes.

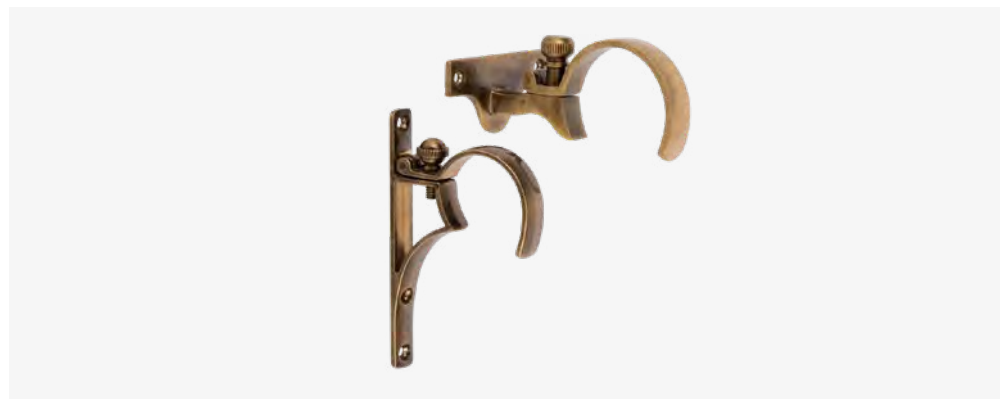

**B13/14 - Overclip Brackets**

These face fixed and centre overclip metal brackets shown in Antiqued Brass come with a strong vertical back plate for the face fixed bracket and a horizontal back plate for the centre bracket to support the pole at different heights. They are designed to clip over corded metal and wooden poles. It fits corded poles from 38mm up to 76mm in diameter. They can be used with decorative facings from our range. Also available in other finishes.



**B15 - Polished Nickel Architrave Bracket**

This face fixed metal bracket comes with a strong vertical back plate to support the pole at different heights and it has a standard round facing to keep the pole in place. It fits poles from 25mm up to 76mm in diameter. They can be used with more decorative facings from our range. Other finishes are available.

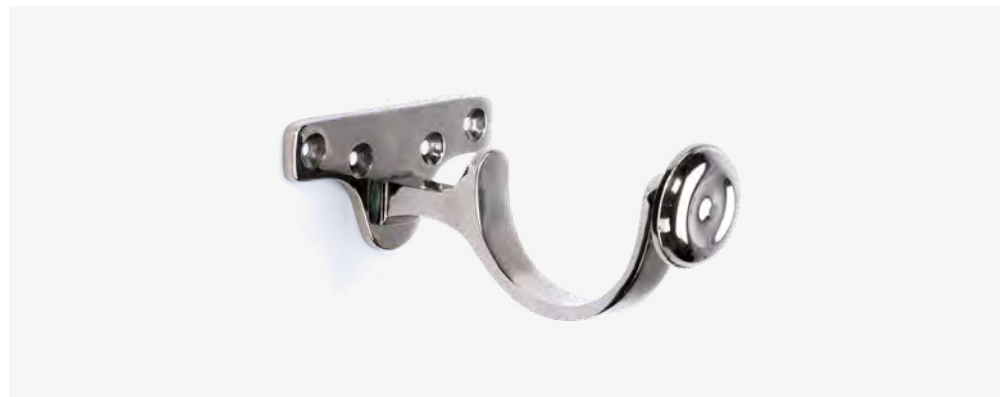

**B11 - Extendable 10-15cm Brackets**

This metal centre bracket has a more discreet back plate and comes with a standard round facing to keep the pole in place. Please note that only the 63mm diameter bracket comes with 4 screw holes on the back plates. It fits poles from 25mm up to 76mm in diameter. They can be used with more decorative facings from our range. Other finishes are available.



**B30 - Polished Nickel 10cm Brackets**

These face fixed and centre metal brackets with a 10cm projection to the back of the cup come with a strong vertical back plate for the face fixed bracket and a horizontal back plate for the centre bracket to support the pole at different heights and it has a standard round facing to keep the pole in place. It fits poles from 25mm up to 76mm in diameter. They can be used with more decorative facings from our range. Also available in other finishes.







**Uplift Bracket**

These face fixed and centre metal brackets shown in Antiqued Brass finish are made to order and come with a strong vertical back plate for the face fixed bracket and a horizontal back plate for the centre bracket to support the pole at different heights and it has a standard round facing to keep the pole in place. It fits poles from 25mm up to 76mm in diameter. They can be used with more decorative facings from our range. Also available in other finishes.



**Corner Centre Bracket**

These centre metal bracket shown in Antiqued Brass is made to order and comes with a strong horizontal angled back plate to support bay poles at the angles and at different heights with a standard round facing to keep the pole in place. It fits poles from 25mm up to 76mm in diameter. They can be used with more decorative facings from our range. Also available in other finishes.



**B44 - Double Cup Brackets**

This face fixed metal brackets shown in Polished Nickel and Antiqued Brass come with a strong vertical back plate to support the pole at different heights, they come with standard round bracket facings or Domed Nickel and Perspex facing as shown, this is optional and there are other options available. It fits poles from 25mm up to 76mm in diameter. These brackets are made to order and specifications of pole sizes for first and second cup need to be confirmed as well as distance from wall to first cup and in between cups. Also shown here we have a the architrave and centre double cup brackets with wider back plates if required. They can be used with more decorative facings from our range. Other finishes are available in the same style as the B44.





**B37 - Square Metal Bracket**

This bracket has a more discreet back plate and comes with a standard square facing to keep the pole in place. It fits poles of 38mm, 51mm and 63mm diameter. They can be used with more decorative facings from our range. Other finishes available.



**B41 - C Passing Centre Bracket**

These C passing centre metal bracket comes with a strong horizontal back plate to support the pole at different heights and it has a standard round facing to keep the pole in place. It fits poles from 25mm up to 76mm in diameter. Also available in other finishes.



**B91 - Resin Bracket**

This face fixed resin bracket comes with a strong vertical back plate to support the pole at different heights and it is shown in a gold imitation gilt finish. Available in other gilt and painted finishes. It fits poles of 51mm and 63mm diameter.



**BF1 - Metal Ball Bracket Facing**

Plain metal ball facing shown in an Antiqued Brass finish. Available in other metal finishes.



**BF2 - Cone Bracket Facing**

Layered Birch Cone bracket facing. Available in wood and other finishes.



**BF3 - Flat Decorative Bracket Facing**

Flat decorative resin bracket facing shown in image in SA silver imitation gilt finish. Available in other colours.

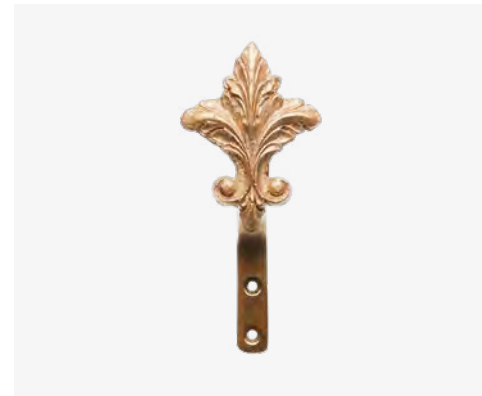

**BF3 - Flat Decorative Bracket Facing**

Flat decorative resin bracket facing shown in image in YG gold imitation gilt finish. Available in other colours.



**BF3 - Flat Decorative Bracket Facing**

Flat decorative resin bracket facing shown in image in YG gold imitation gilt on a B6 antiqued brass centre bracket. Available in other colours.





**BF4 - Wood Bracket Facing**

Wood bracket facing shown in a stained wood finish. Available in other finishes.



**BF5 - Wood Bracket Facing**

Wood bracket facing shown in stain Ebony. Available in other finishes.

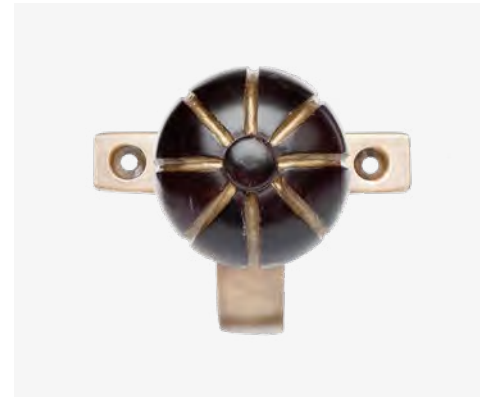

**BF6 - Wood Bracket Facing**

Wood bracket facing shown in a stain finish with imitation gilt detail in the grooves. Available in other finishes.



**BF7 - Hammered Metal Bracket Facing**

Hammered metal bracket facing shown in Polished Nickel. Available in other metal finishes.



**F190 - Antique Gilt**

Image shows 51mm diameter size in Clear Glass and Antique Brass Top and Base. Fits a 51mm diameter pole. Also available in frosted glass and other metal finishes.



**BF9 - Twisted Cone Bracket Facing**

Twisted Cone bracket facing shown in main image in Bronze imitation gilt and in second image in AL imitation gilt finish. Available in other finishes.

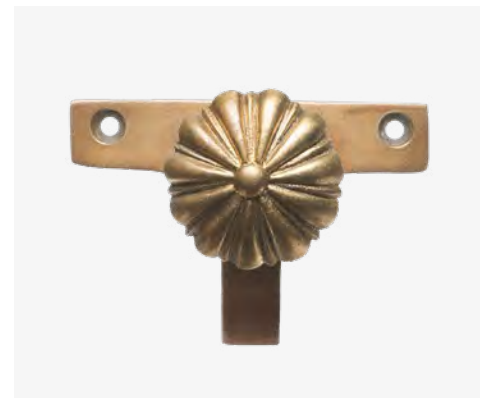

**BF10 - Ribbed Metal Bracket Facing**

Ribbed meta bracket facing shown in Antiqued Brass finish. Available in other finishes.



**BF11 - Resin Sunflower Bracket Facing**

Resin Sunflower bracket facing shown AL2 imitation gilt finish. Available in other finishes.





**BF14 - Glass Coloured Centre Bracket Facing**

Glass coloured centre bracket facing shown in the image with purple centre. Available in other colours.



**BF12 - Metal Small Dome Bracket Facing**

Metal small dome bracket facing shown in Polished Nickel finish. Available in other finishes.



**BF13 - Glass Silver Kyoto Bracket Facing**

Glass silver Kyoto bracket facing. Also available in gold Kyoto.



**BF14 - Glass Coloured Centre Bracket Facing**

Glass coloured centre bracket facing shown in the image with blue centre. Available in other colours.



**BF14 - Glass Coloured Centre Bracket Facing**

Glass coloured centre bracket facing shown in the image with frosted glass centre. Available in other colours.





# Finishes

We have a variety of finishes available in metal, wood, and resin. We have imitation gilt, water gilt, metal finishes, basic stain colours and a small selection of paint effects and dirty varnish colours to give you a taste of what we can do. We also offer a colour matching service to work with every design project where our standard finishes are not quite right, and a more individual treatment is required.

**Gold Gilt**



**Silver Gilt**



**Wood Stain**



**Painted Wood**



**Metal Finishes**





# Gold Gilt



Gilt DM Finish



Gilt AL Finish



Gilt AL2 Finish



Gilt BC Finish



Gilt BK Finish



Gilt DMR Finish



Gilt EA Finish

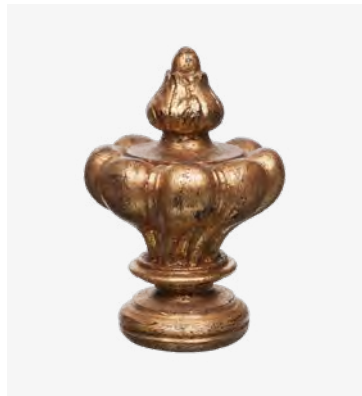

Gilt EC Finish

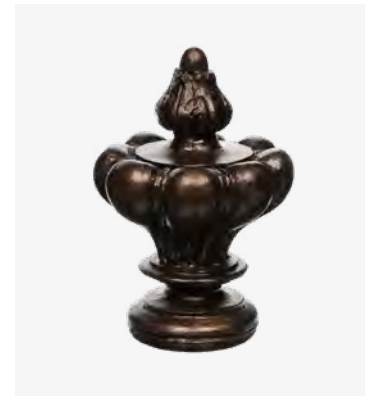

Gilt Bronze Finish

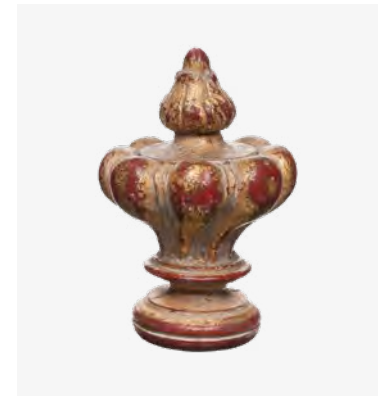

Gilt LA Finish





# Gold Gilt



Gilt GB Finish

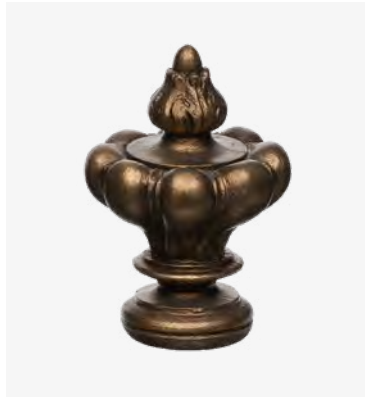

Gilt GG Dark Finish



Gilt GG Finish

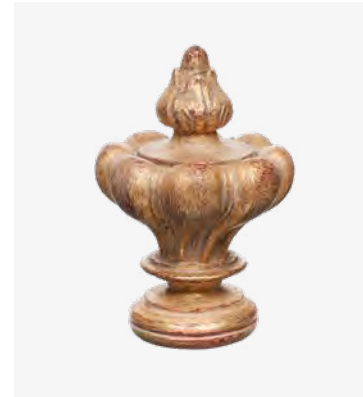

Gilt KA Finish

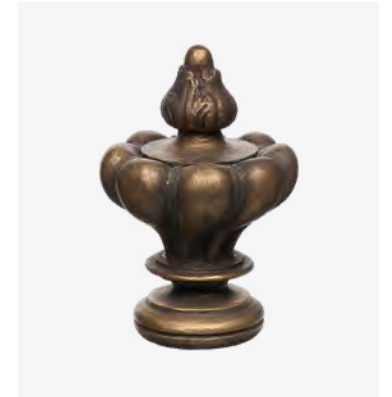

Gilt OB Finish

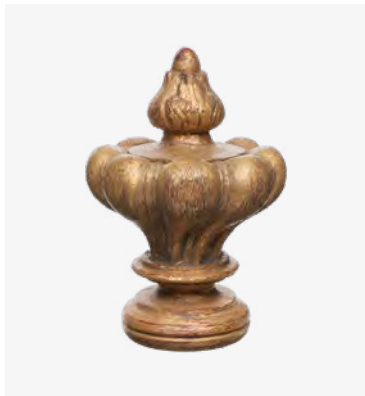

Gilt YVR Finish

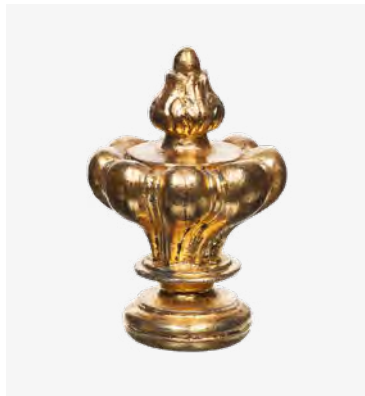

Watergilt AA Finish



Watergilt BA Finish



Watergilt BB Finish

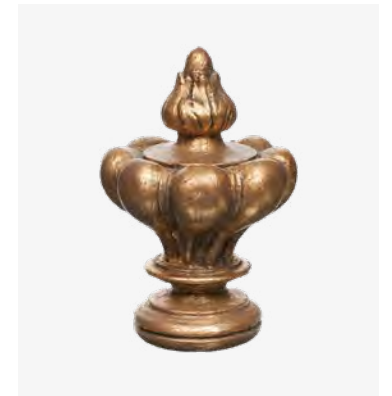

Gilt YG Finish





# Silver Gilt



Watergilt AF Finish



Watergilt AO Finish



Gilt ED Finish

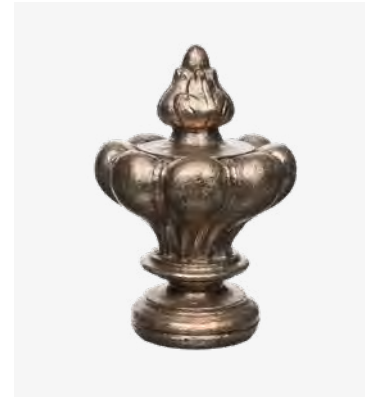

Gilt Ant Pewter



Gilt SA Custom



Gilt SB Custom



Gilt SC Finish



Gilt SD Finish

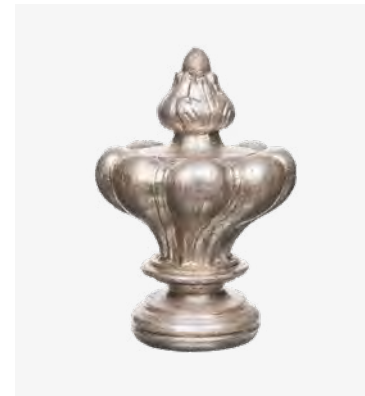

Gilt SJ Finish





# Wood Stain



Distressed Wood



Stain 22 - High Gloss



Light Oak



Stain 3



Stain 8



Stain 12R



Stain 12



Stain 13



Stain 16



Stain 26



Stain 35





# Painted Wood



Elephants Breath



Verdigris



NV1



NV2



NV3



NV5



NV6



NW1



NW2



# Metal Finishes



Polished Nickel



Antique Silver



Satin Nickel



Antique Gilt

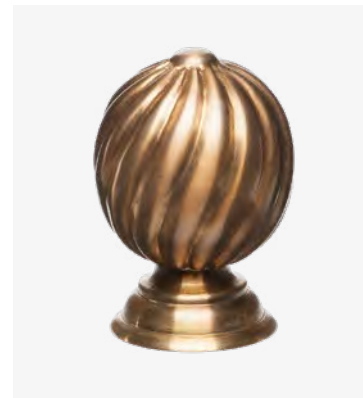

Light Antiqued Brass

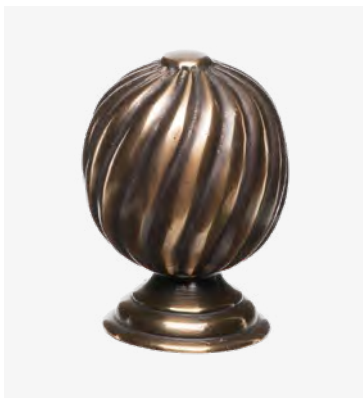

Antiqued Brass - Two Tones

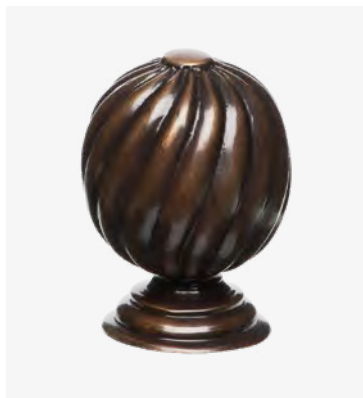

Antique Bronze

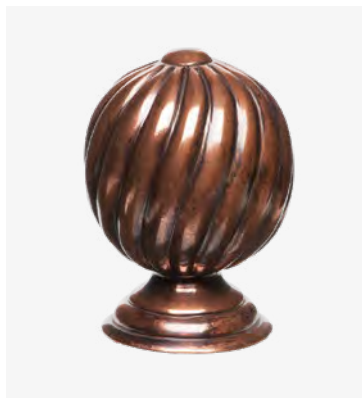

Copper

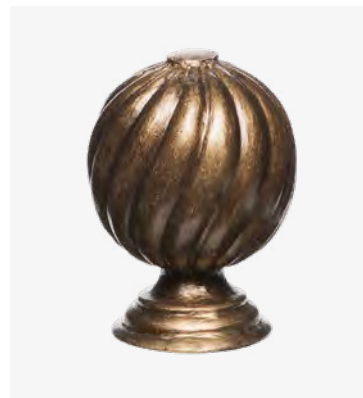

Resin in GG Gilt

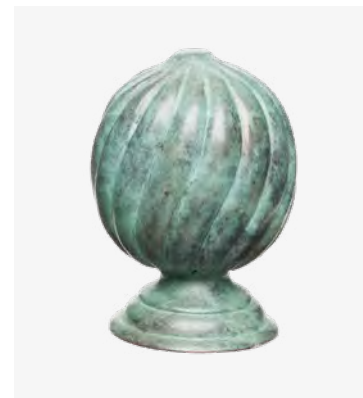

Verdigris





# Guideline



# Hollow Ring Dimensions

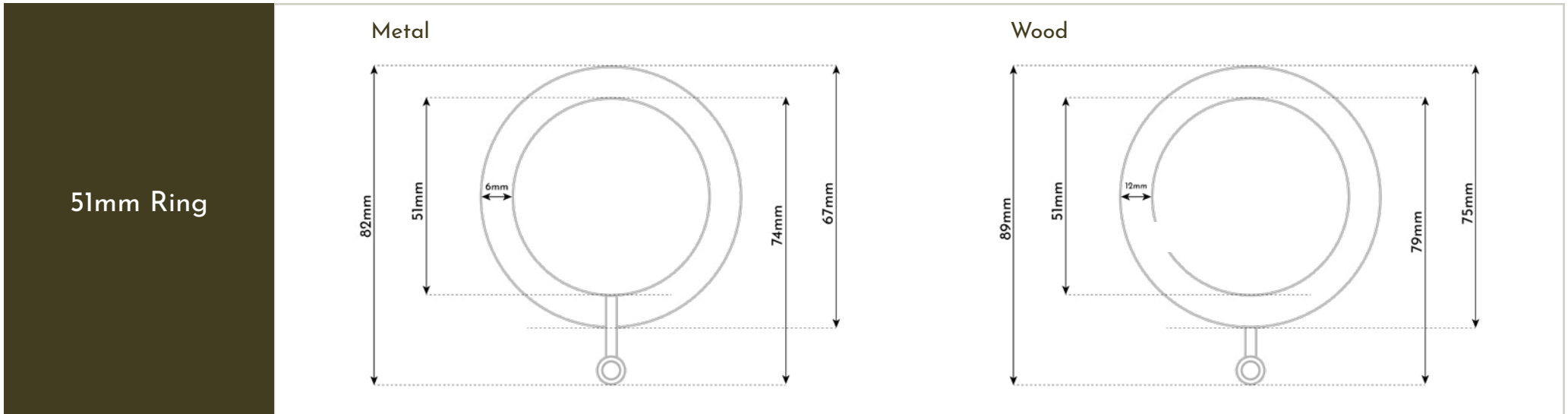
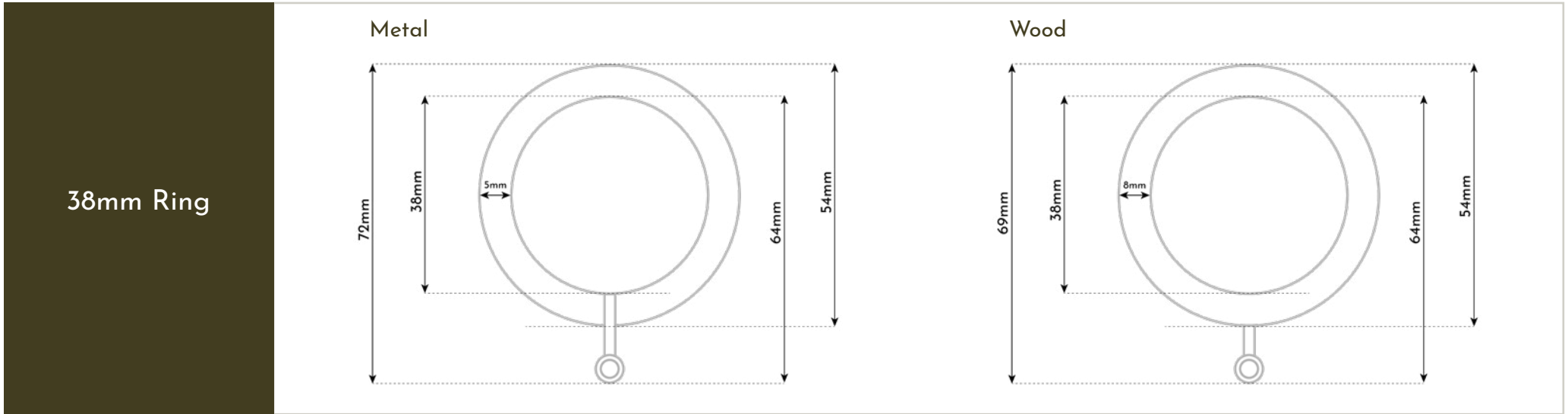



# Hollow Ring Dimensions

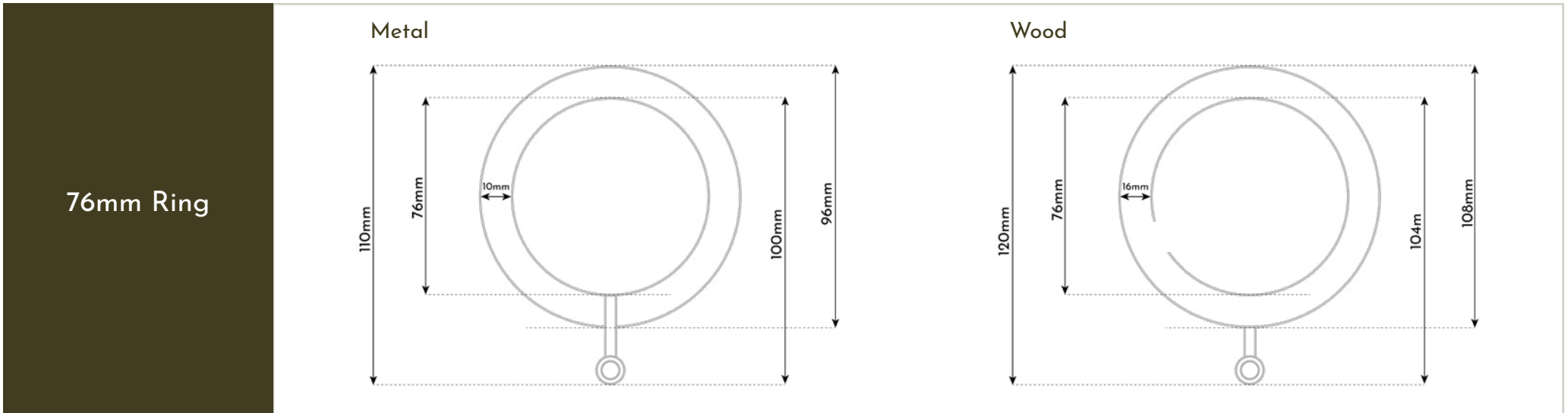
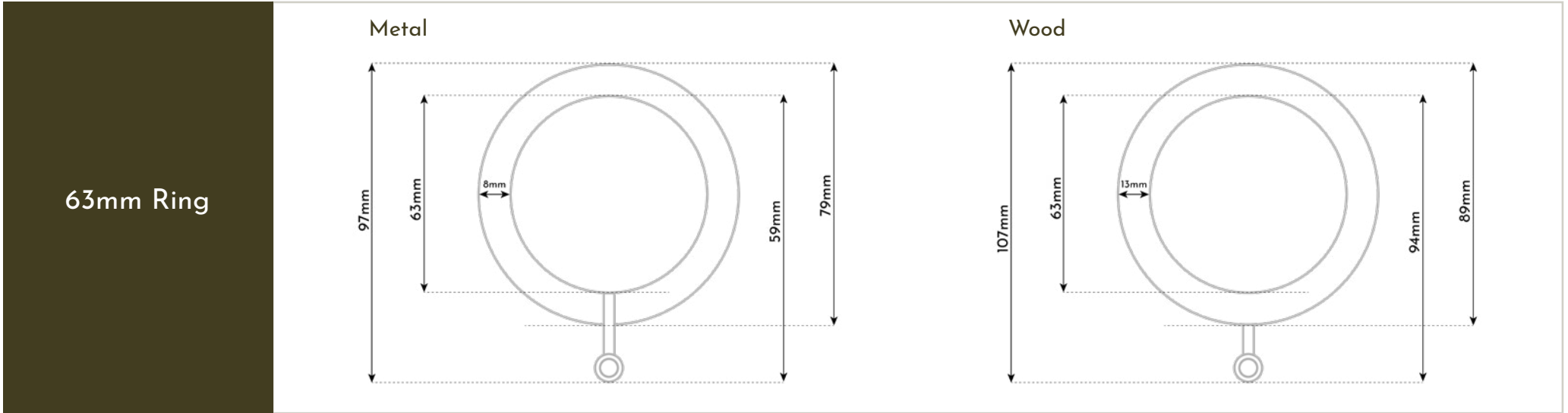



# Hollow Ring Dimensions

## 89mm Ring

Metal

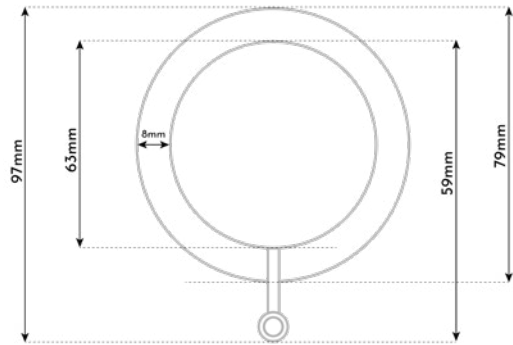

Wood

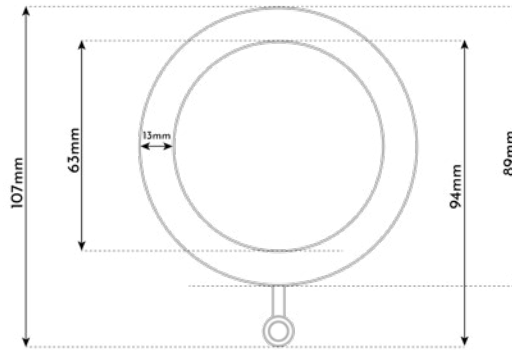

Wood

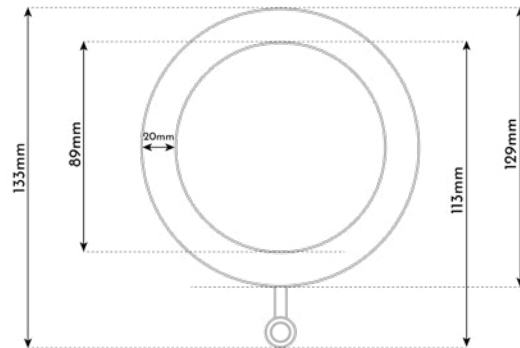

## 20mm Black Iron Ring

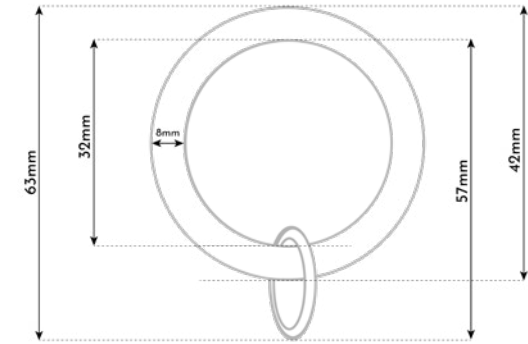

# Bay Windows

**Swept Bay**

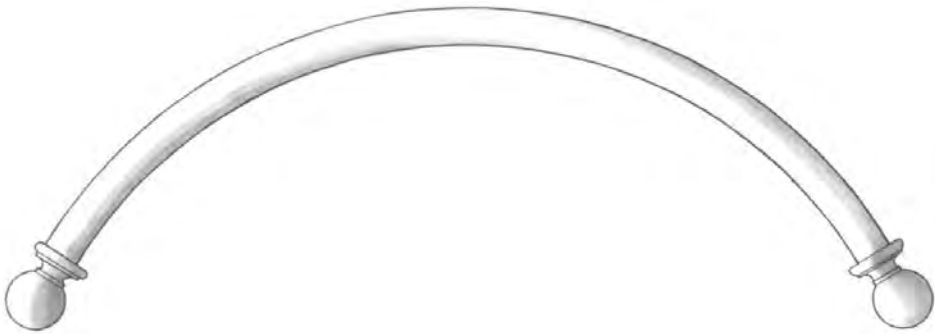

**Measuring Requirements**

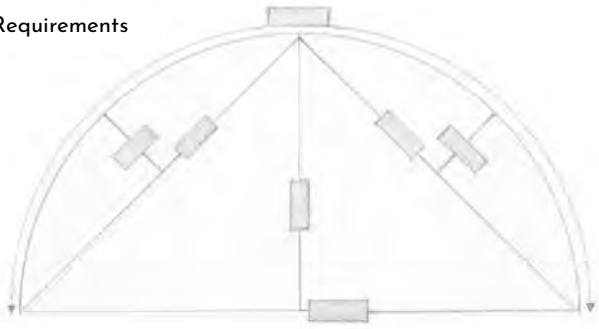

**Angled Bay**



**Measuring Requirements**

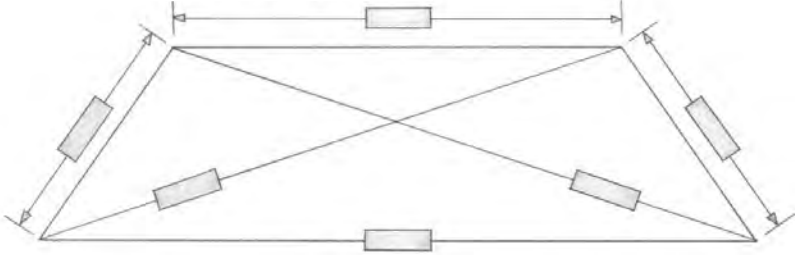





# Terms & Conditions



# The McKinney Collection Terms & Conditions

## Postage and Packaging

Delivery is £25.00 PER SET for all UK orders (non refundable) We are happy to despatch orders overseas. The delivery charges to countries outside the UK (including the Channel Islands) are charged at actual delivery cost. Please call for a delivery charge quote on 020 7627 5077.

## Dispatch Date

We will give 1 to 2 weeks maximum wait for a set however some can be ready on the day especially accessories. Please enquire on 0207 627 5077.

## Delivery

Delivery is made by a carrier and does require an authorised signature. Please have your goods delivered to an address where someone will be available to accept your order. Normal delivery is 1-3 days. If an item is urgently required, we can assist, please call on 020 7627 5077. If you wish to collect the goods personally, you may indicate this when ordering and delete the £25.00 delivery charge on the order form.

## Dimensions

All dimensions given are approximate.

## Stock and Pricing

All prices exclude VAT. We endeavour to maintain a stock of all products at all times. Sometimes we cannot accurately forecast demand for certain products, if we are out of stock we will notify you of an expected delivery date.

## Returns and Exchanges

1. Please enclose a copy of your original invoice that you received with your order.
2. Please pack items to return carefully.
3. Please obtain a proof of purchase certificate.
4. Let us know if you would like to exchange your order for other items.
5. Goods arriving damaged must be notified in writing within 5 days - these will be collected and replaced at no cost.
6. All returns should be sent to:

**McKinney and Co**  
**Unit 19 Eurolink Business Center**  
**49 Effra Road**  
**London SW2 1BZ**



## The McKinney & Co Bespoke Terms & Conditions

1. Poles are priced to the nearest 1/4m, except Perspex poles which are priced to the nearest 1/2m.
2. Centre brackets are recommended on poles over 2m (6ft) 1.25mt for 25mm poles, 1.75mt for 38mm poles, 2mt for 51mm poles, 2.5mt for 63mm poles.
3. Rings need to be 1/2" larger than the diameter of the pole and should be calculated at one every 10cm (4").
4. Items made in wood or resin are available in their natural finish. Any finishing requirements must be added to this basic cost.
5. Brass items can be Antiqued, Bronzed, Chrome or Nickel plated at an additional cost unless otherwise stated. Other finishes are available on request.
6. Returns on pelmets must be added to the internal measurement to calculate cost.
7. Colours shown are for guideline purposes only and this is only a small selection of colours available. A matching service is available at a cost of £30 pounds.
8. Measuring and Fitting charges on request.
9. Orders cannot be started without written confirmation and a 50% deposit.
10. Orders cannot be started without written confirmation and a 50% deposit.
11. Measurements on drawings are only approximate. Please specify if exact measurements are required.
12. Our Terms and Conditions are available upon request.
13. No responsibility will be taken for inappropriately chosen items or badly fitted goods.
14. Any changes to orders after the deposit has been received may result in a delayed delivery date and/or an additional charge.
15. No responsibility can be taken for Pelmets & Coronas which are delivered outside London and which are not packed by specialists.
16. Goods must be collected within 4 months from the final invoice to avoid storage being charged.
17. To give our trade discount we require a trade purchase order and all invoices will be made out to this trade name.
18. We will only accept returns in exceptional circumstances i.e. Damaged goods or wrong orders delivered due to an error on our part. In order to give credit in such circumstances we must receive written/faxed notification within 2 days of receipt of the order.

# McKinney & Co

BRITISH CURTAIN POLES & FINIALS

## COLLIER WEBB SHOWROOM

2nd Floor South Dome  
Design Centre, Chelsea Harbour  
London, SW10 OXE, United Kingdom

Tel: +44 (0) 20 7627 5077  
[sales@mckinney.co.uk](mailto:sales@mckinney.co.uk)

[mckinney.co.uk](http://mckinney.co.uk)  
[@mckinneyandco](#)

Part of The Edward Alexander Group

